



SERVICE MANUAL & SPARE PARTS LIST

H750



H750 NL

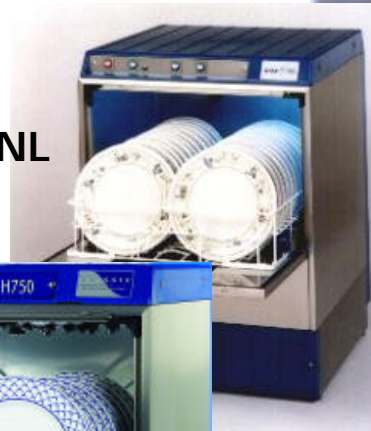

H7

DISHWASHERS
H750 (Stainless Steel Top)
H750NL
H7
All Known as Hydro 750

CLASSIC HOUSE, AIRFIELD INDUSTRIAL ESTATE, HIXON, STAFFORDSHIRE ST18



December 2003 WO

BLANK



CLASSIC H750 DISHWASHER



H750

Stainless Steel Top Machine
Introduced 1995
2 Minute Timer
No Drain Plug
3 Minute Drain Timer
All machines have
DRAIN PUMPS

NEW LINE Machines with BLUE PLASTIC Top Introduced 1998
Added Features : Heat interlock on washing cycle
'Load it and leave it '



H750 NL

24 Volt Range of Glass & Dishwashers
Introduced in April 2002
New Control Circuit
New Switch Arrangement



H7

In August 2003, internally, the electric circuits changed
Although the outwood appearance remained the same.

BLANK



HYDRO 750 / 750NL / H7

PAGE 1	CONTENTS
	PARTS LISTS
PAGE 2	CABINET & COVERS DRAWINGS
PAGE 3	CABINET & COVERS PARTS LIST
PAGE 4	RINSE SYSTEM DRAWING
PAGE 5	RINSE SYSTEM PARTS LIST
PAGE 6	WASH & JET SYSTEM DRAWING
PAGE 7	WASH & JET SYSTEM PARTS LIST
PAGE 8	WATER & WASTE SYSTEM DRAWING (8A & 8B - Boss / Spigots & Filters)
PAGE 9	WATER & WASTE SYSTEM PARTS LIST
PAGE 10	FILTER SYSTEM DRAWING
PAGE 11	FILTER SYSTEM PARTS LIST
PAGE 12	ELECTRICAL STAINLESS STEEL TOP MODEL H750
PAGE 13	ELECTRICAL S/STEEL PARTS LIST H750
PAGE 14	ELECTRICAL H750 NL MODELS
PAGE 15	ELECTRICAL H750 NL PARTS LIST
PAGE 16	Wash Pump Variations
PAGE 17 & 18	AIR BREAK TANK PARTS ALL H750 WIRING
PAGE 19	H7 24 VOLT SPARE PARTS - UNIQUE 24 VOLT PARTS
PAGE 20	H7 24 volt Rev H (Aug 2003) Spare Parts - 24 Volt Parts

H750 Drawings

PAGE 21	H750 S/S STEEL TOP WIRING WITH B9
PAGE 22	H750 S/S STEEL TOP WIRING WITH B6
PAGE 23	H750 S/S TOP COMPONENT
PAGE 24	H750 N L PRIOR TO Ser No 19700
PAGE 25	H750 N L Ser 19700 TO ?? -811
PAGE 26	H750 N L ??-811 TO ??-909
PAGE 27	H750 N L ??-909 ???-215
PAGE 28	H750 N L Component Wiring
PAGE 29	H750 N L Interlock Circuit—Start
PAGE 30	H750 N L Interlock Circuit - Changover

DRAWINGS

APRIL 2002 24Volt Machine

H7 (24 Volts)

Page 31	Issue 1 H7 COMPONENT WIRING
Page 32	Issue 1 H7 WIRING DIAGRAM
Page 33	Issue 1 H7 AB Component Wiring
Page 34	Issue 1 H7 AB Wiring Diagram
Page 35	Issue 2 H7 Component Wiring
Page 36	Issue 2 H7 Wiring Diagram
Page 37 & 38	Issue 2 H7 AB Com& Wiring Diagram
Page 39	- to remove interlock
Page 40 / 41 / 42	Training aid & Common Faults

AUGUST 2003 24 Volt Machine

H7 (24 Volts)

Page 43	H7 Component Wiring
Page 44	H7 WIRING DIAGRAM
Page 44A	H7 Wiring January 2004
Page 44B	H7ABT Wiring January 2004
Page 45	Fitting Internal Rinse Booster Pump to H7
Page 46	Soap PCB Board Settings & adjustments

CLASSIC HOUSE, AIRFIELD INDUSTRIAL ESTATE, HIXON , STAFFORDSHIRE ST18 0PF

December 2003 WO

H 750 / H750NL/H7 CABINET & COVERS

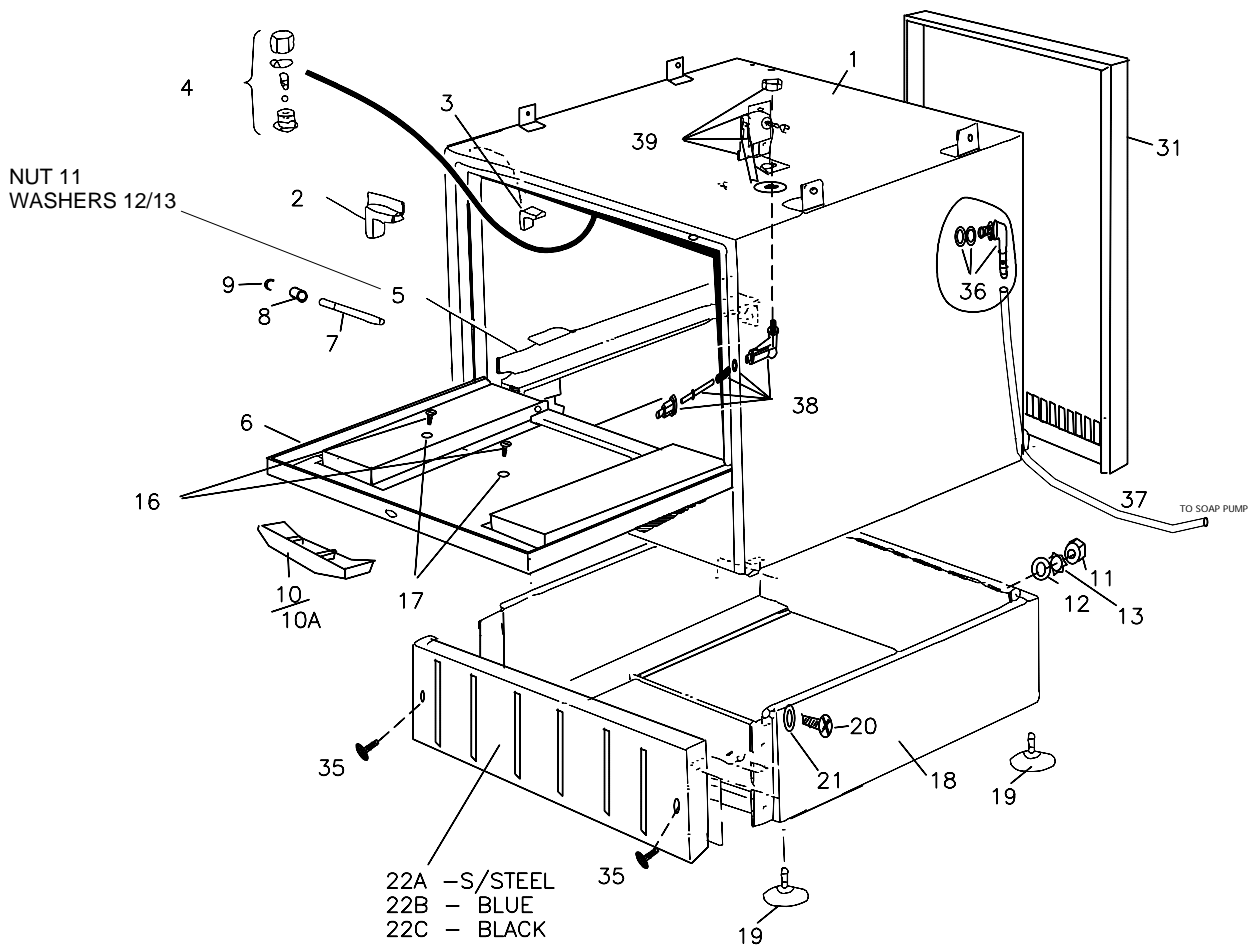
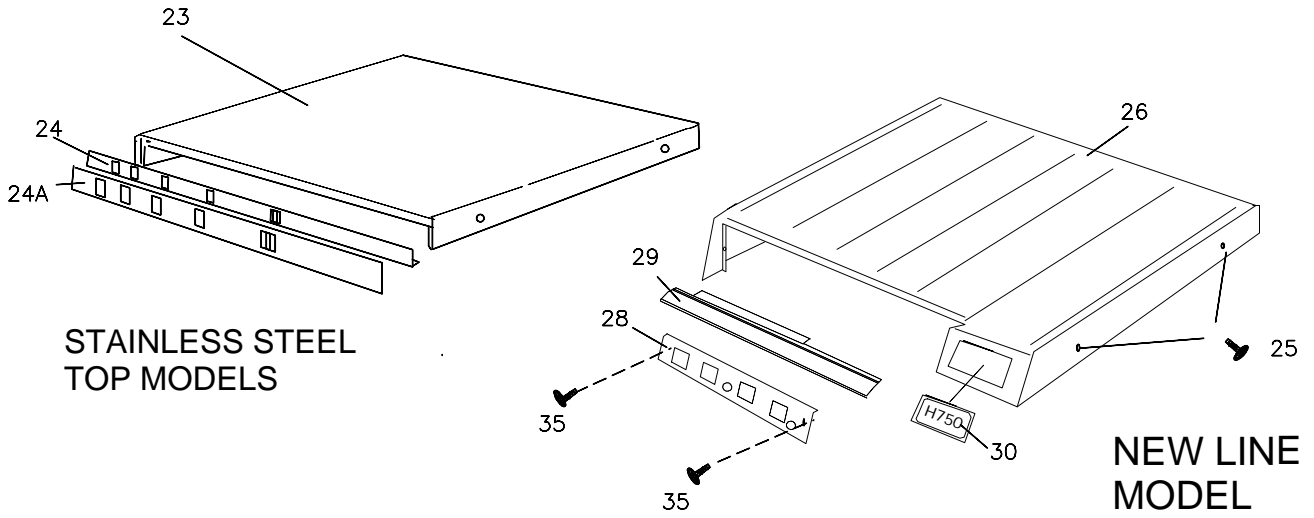

HYDRO 750 / 750 NL / H7

CABINET & PANELS



NOT SHOWN

ITEM	DESCRIPTION	PART No
1	CABINET	10.2.4/1
2	EXTERNAL CORNER PIECE	7.2.15
3	INNER CORNER PIECE	7.2.14
4	BALL CATCH ASSEMBLY	7.2.10
5	BASKET RUNNER RIGHT HAND	10.2.21R
	BASKET RUNNER LEFT HAND	10.2.21L
6	DOOR	14.2.5/1
7	DOOR PIN	10.2.16/1
8	SPACER FOR DOOR PIN	7.2.35/2
9	CIRCLIP FOR DOOR PIN	7.2.35/1
10	BUSH INSERT FOR DOOR PIN	7.2.35/3
10A	BLUE PLASTIC HANDLE	7.6.6.3
	BLACK PLASTIC HANDLE	7.6.6.2
11	NUT	11.2.3
12	WASHER	W011
13	STAR WASHER	7.2.36/8
16	SCREW FOR DOOR HANDLE	7.2.36/4
17	O RING	7.2.36.4
18	BASE	10.2.7/1
19	FOOT	7.2.37
20	CABINET SCREW	7.2.36
21	WASHER	7.2.41
22A	FRONT PANEL STAINLESS STEEL	10.2.8/1
22B	FRONT PANEL BLUE PLASTIC	10.2.8P
22C	FRONT PANEL BLACK PLASTIC	10.2.8P-UL
23	TOP - STAINLESS STEEL	10.2.2/1
24	FACIA PANEL - STAINLESS STEEL	10.2.2/3
24A	PLASTIC FACIA FOR ITEM 24 H750	FASC/H750
	PLASTIC FACIA FOR ITEM 24 ECO3	FASC/ECO3
25	PANEL SCREW	7.2.40/1
26	TOP PANEL - BLUE PLASTIC	10.2.1P
	TOP PANEL - BLACK PLASTIC	10.2.1P-UL
28	FACIA PANEL - NEW LINE - H750	10.2.2S
	FACIA PANEL - NEW LINE - ECO3	10.2.2S/1
	* FACIA PANEL - H7 (4/02 onward)	10.2.57
	* Stick on facia label H7 (4/02 onward)	FASCH750/NL2
	** FACIA PANEL - E3 (4/02 onward)	10.2.57
	** Stick on facia label E3 (4/02 onward)	FASCE3/NL2
29	SUPPORT FOR FACIA - BLUE PLASTIC	10.2.2PI
	SUPPORT FOR FACIA - BLACK PLASTIC	10.2.2PI-UL
30	BADGE FOR PLASTIC TOP - H750	LABEL-H7
	BADGE FOR PLASTIC TOP - ECO3	LABEL-E3
31	BACK PANEL BLUE	10.2.3S
	BACK PANEL BLACK	10.2.3S-X
35	LONG PANEL SCREW	7.2.40/3
36	SOAP ELBOW	7.2.21/ASS
37	SOAP TUBE	RT2
38	DOOR PLUNGER ASSEMBLY	7.14.1
39	DOOR MICRO SWITCH ASSEMBLY	7.14.10/1

H750 / H750NL /H7 RINSE SYSTEM

RINSE AID INJECTOR FITTING KIT
MODIFICATION
 See MOD KIT to convert Brass Nut Type
 with Hard Plastic Tube to Silicon Tube and
 Clip connections.
 Part No 7.7.0/23A

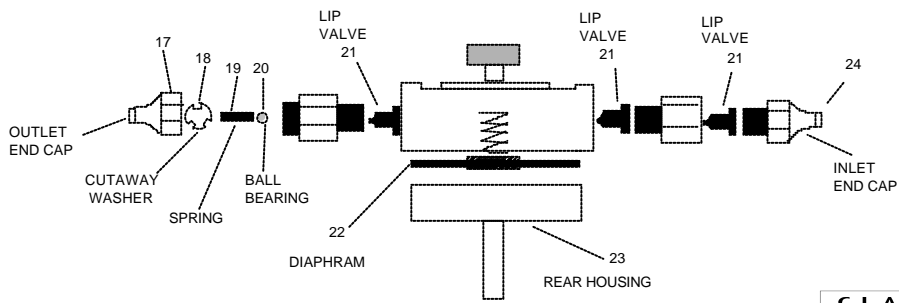
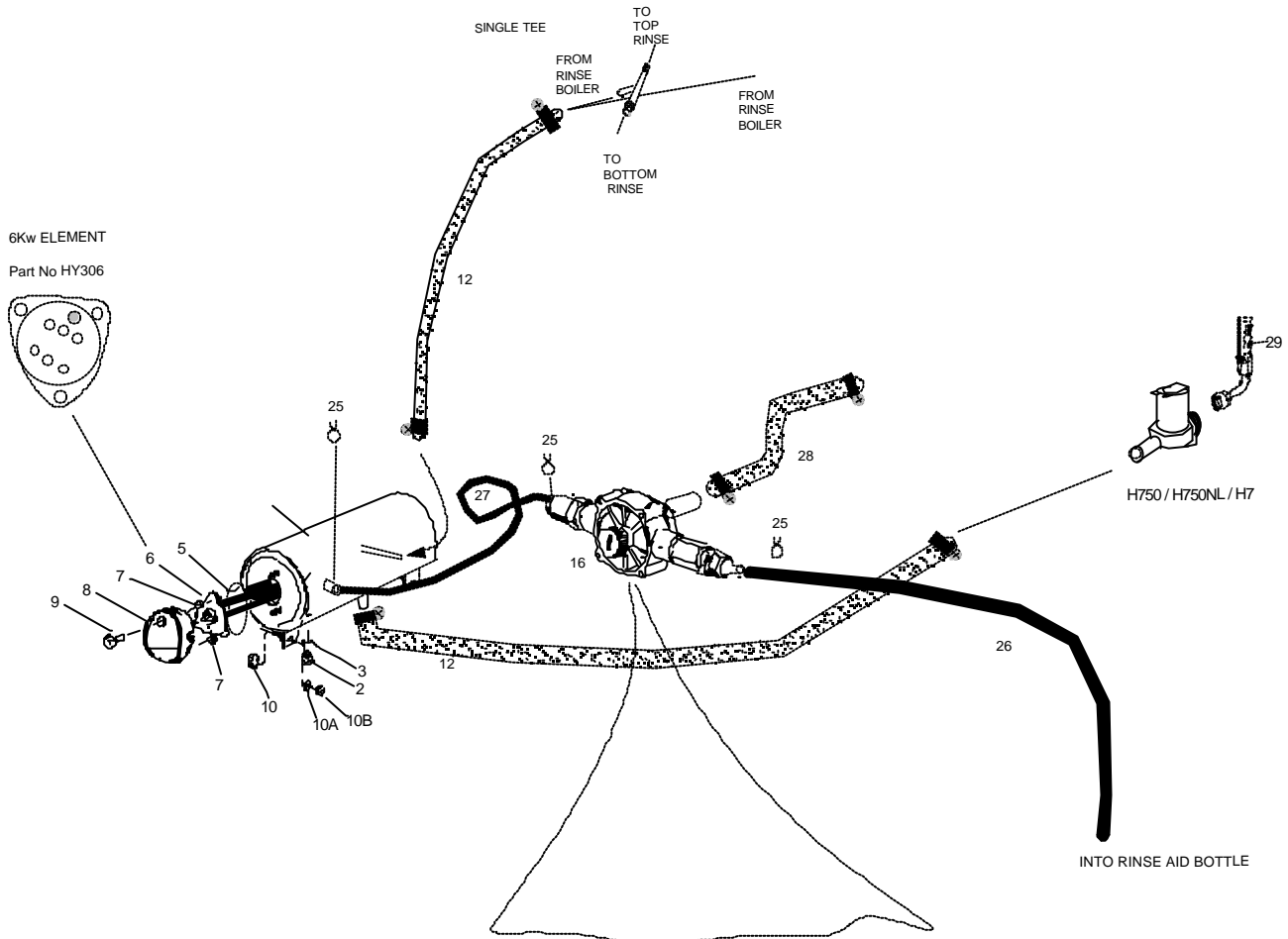

RINSE AID INJECTOR - REMOTE TYPE





HYDRO 750 / 750 NL / H7

RINSE SYSTEM

ITEM	DESCRIPTION	PART No
H750 RINSE TANK PARTS		
1	RINSE TANK	10.9.1/3
2	DRAIN BOLT	7.9.5
3	SEAL	7.9.6
5	SEAL FOR ELEMENT	HY307
6	ELEMENT - 6kw	HY306
7	NUT	11.2.3
8	COVER	7.9.15/1
9	NUT FOR COVER	7.9.16/1
10	NUT	11.2.3
10A	WASHER	7.2.42
10B	BOLT	7.9.13/4

11	HOSE CLIP	7.4.12/1
12	RINSE HOSE	8.8.15
13	SINGLE INLET WATER VALVE	7.12.12/1
15	SINGLE TEE 11mm	7.15.2
16	RINSE AID INJECTOR	7.7.0.1/1

Parts in Rinse aid injector

17	OUTLET END CAP	7.7.0/10
18	CUT AWAY WASHER	N/A
19	SPRING	N/A
20	BALL BEARING	N/A
21	LIP VALVE	7.7.12
22	DIAPHRAM	7.7.17
23	REAR HOUSING	7.7.0/15A
24	INLET END CAP	7.7.0/17
25	CLIP FOR TUBE	7.7.0/22
26	TUBE	RT2
27	BLACK RUBBER TUBE	8.8.16
28	PIPE	7.7.0.1/2
29	WATER INLET HOSE	7.8.14

December 2003 WO

H750 / H750NL / H7 WASH SYSTEM

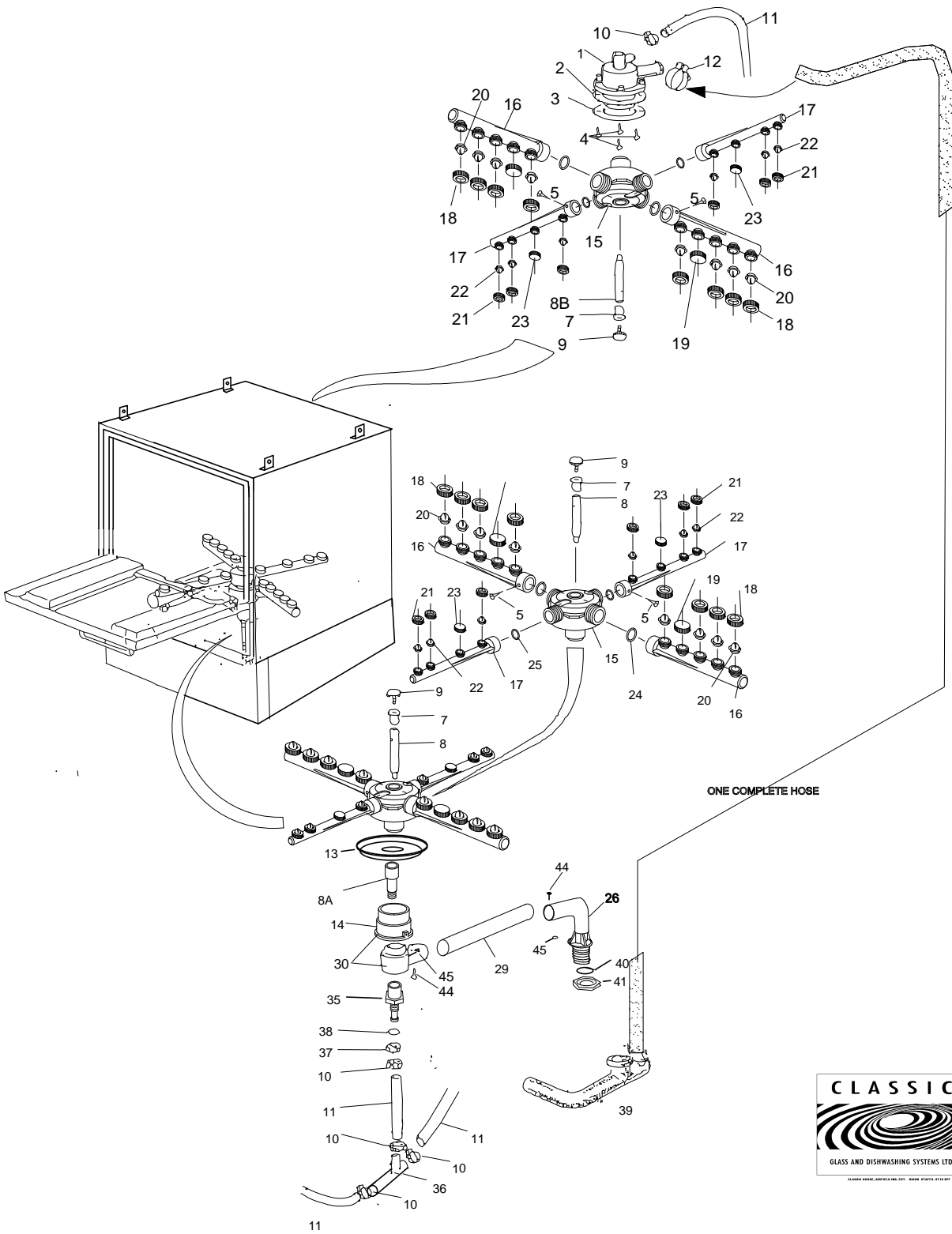

HYDRO 750 / 750 NL / H7

WASH & JET SYSTEM



ITEM	DESCRIPTION	PART No
1	TOP BOSS	12.2.1/4A
2	GASKET	12.2.2
3	TOP FLANGE	13.2.11/1
4	SCREW	SC005A
5	SELF TAP SCREW FOR ARMS	7.4.17/1
7	BUSH FOR CENTRE BOSS	11.1.9
8	BOTTOM SPINDLE 8MM	11.1.7/2
8A	BOTTOM SPINDLE SPACER	11.1.7/7
8B	TOP SPINDLE 8MM	11.1.7/2
9	SPINDLE BOLT	11.1.8/2
10	HOSE CLIP	7.4.12/1
11	RINSE HOSE	8.8.15
12	HOSE CLIP	7.4.12/5
13	BOTTOM FLANGE	11.1.10/6
14	SPACER FOR BOTTOM BOSS	13.1.10/4
15	CENTRE BOSS	11.1.0/1
16	WASH ARM	14.1.6/5
17	RINSE ARM	14.1.6/6
18	WASH JET NUT	11.1.6/7
19	WASH JET BLANK	11.1.6/8
20	WASH JET Left (S)	11.1.6/9
20	WASH JET Right (D)	11.1.6/10
21	RINSE JET NUT	11.1.6/11
22	RINSE JET	11.1.6/12
23	RINSE JET BLANK	11.1.6/14
24	O SEAL (Wash) OLD STYLE ARMS ONLY	11.1.6/15
25	O SEAL (Rinse) OLD STYLE ARMS ONLY	11.1.6/16
26	WASH ELBOW (one piece)	11.1.2/4A
29	CROSS TUBE	14.1.4
30	BOTTOM BOSS WITH SPACER	11.1.5/3
35	SUPPORT	14.1.10/4
36	SINGLE TEE PIECE	7.15.2
37	NUT FOR SUPPORT	7.3.13
38	O SEAL FOR SUPPORT	7.5.9
39	HOSE - WASH PUMP OUTLET	14.2.10/A
40	O SEAL	9.8.13
41	NUT	7.8.6
44	SCREW 5mm	11.1.3
45	NUT 5MM	7.2.41

December 2003 WO

H750 / H750NL / H7 WATER & WASTE SYSTEM

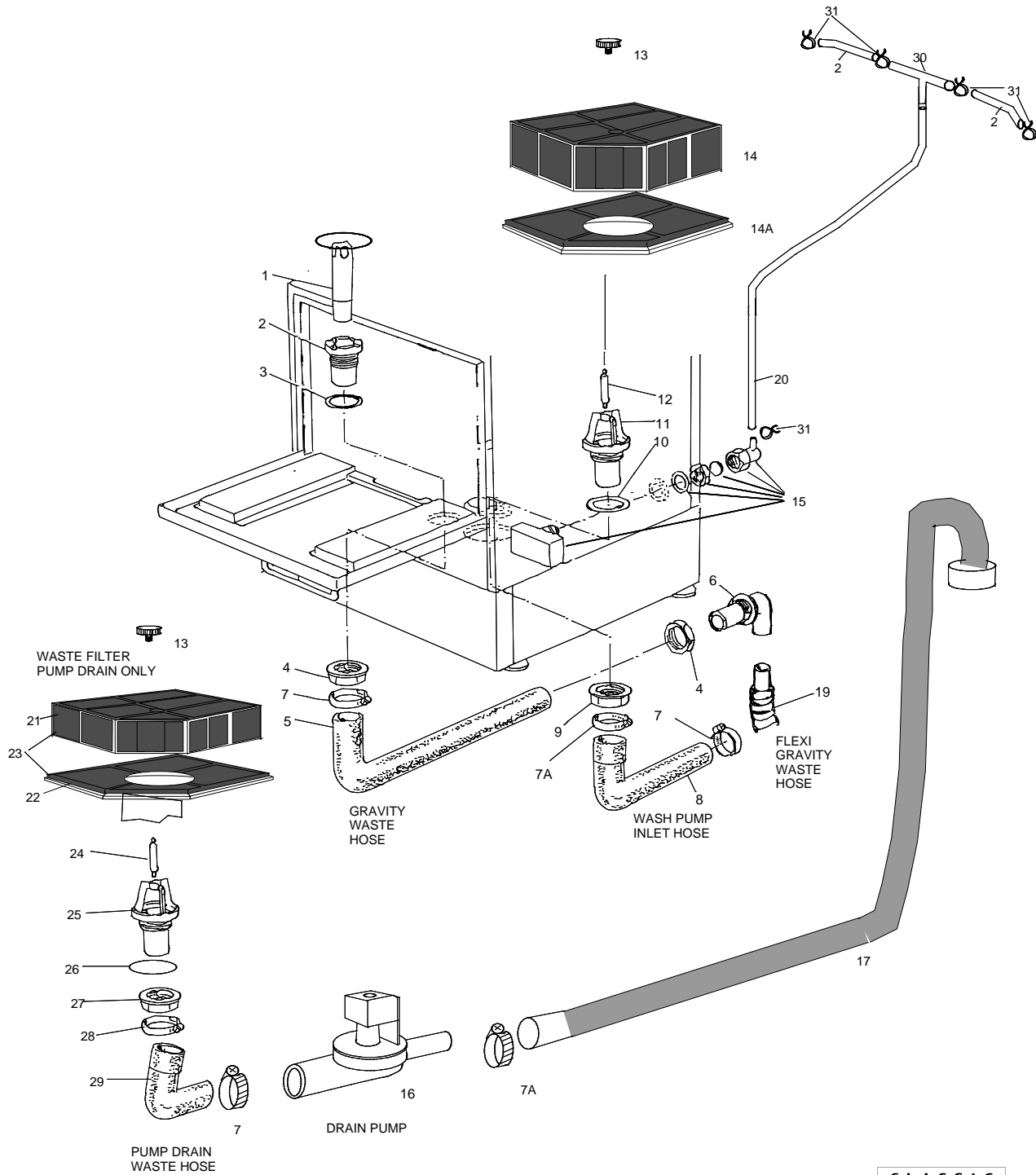

December 2003 WO

CUT OFF ALONG THIS LINE AND DISCARD THE TOP HALF



H750

PAGE

8A

WASTE FILTERS

H750 STAINLESS TOP M/CS & EARLY NEW LINE

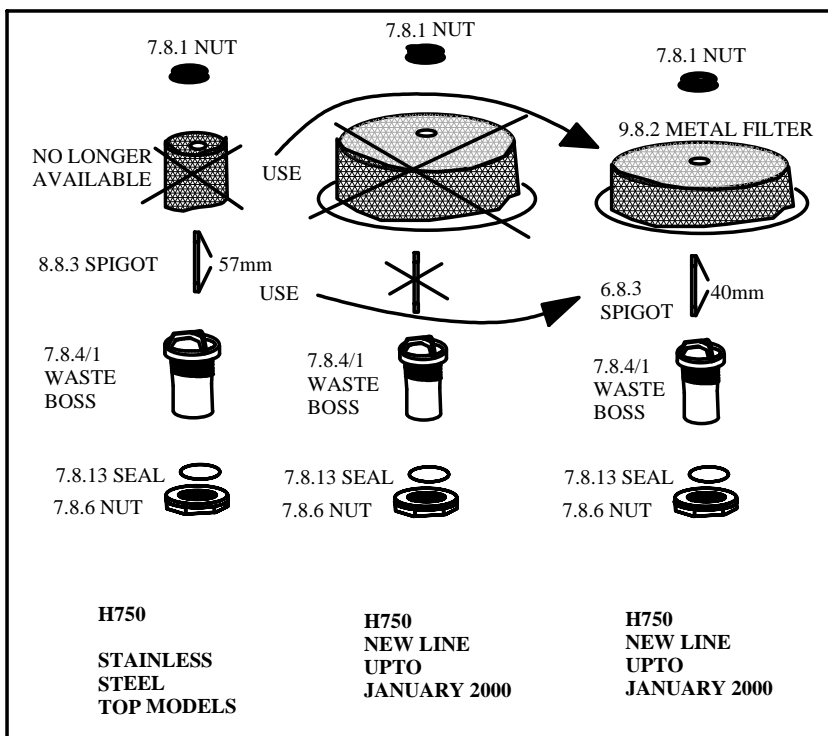

H750 NL FROM 2001

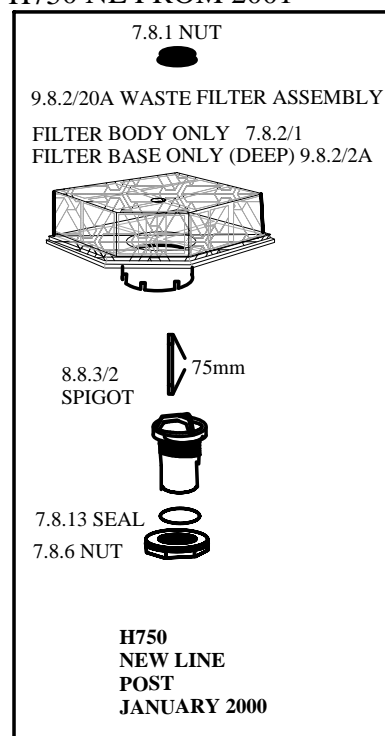

CUT OFF ALONG THIS LINE AND DISCARD THE TOP PART

8B



H750

WASH PUMP FILTERS

**H750
PRIOR TO
JAN 2000**



7.8.1 NUT

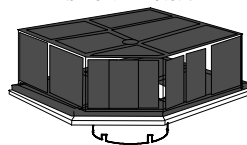

9.8.2/A ASSEMBLY
SHALLOW

BODY ONLY - 9.8.2/B
BASE ONLY - 9.8.2/2



8.8.3/1
SPIGOT  75mm

9.8.4
WASH
BOSS 

9.8.13 SEAL 
9.8.6 NUT 

**H750
POST JAN 2000**



7.8.1 NUT

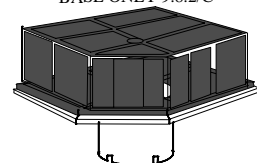

9.8.2/D ASSEMBLY
DEEP

BODY ONLY 9.8.2/B
BASE ONLY 9.8.2/C



8.8.3/2
SPIGOT  85mm

9.8.4
WASH
BOSS 

9.8.13 SEAL 
9.8.6 NUT 

HYDRO 750 / 750 NL / H7

WATER & WASTE SYSTEM



ITEM	DESCRIPTION	PART No
1	DRAIN PLUG - GRAVITY DRAIN ONLY	10.10.10/G
2	WASTE BOSS	9.10.2
3	O SEAL	7.8.13
4	NUT	7.8.6
5	WASTE OUTLET HOSE	9.10.3A
6	OUTLET ELBOW	9.10.4A
7	CLIP FOR HOSE	7.4.12/4
7A	CLIP FOR HOSE	7.4.12/3
8	INLET HOSE FOR WASH PUMP	9.8.5/2
9	NUT	9.8.6
10	O SEAL	9.8.13
11	WASH FILTER BOSS	9.8.4
12	FILTER SPIGOT	8.8.3/1
13	FILTER NUT	7.8.1
14	PLASTIC FILTER BODY	9.8.2/B
14A	PLASTIC FILTER BASE	9.8.2/2
	COMPLETE WASH FILTER	9.8.2/D
15	AIR TRAP ASSEMBLY	7.11.1AA
16	DRAIN PUMP	DP2
17	WASTE HOSE FOR DRAIN PUMP	DP-HOSE
19	WASTE HOSE FOR GRAVITY	HY305
20	TUBE FOR PRESSURE SWITCH	RT3
21	WASTE FILTER - TOP PART	7.8.2/1
22	WASTE FILTER - BOTTOM PART	9.8.2/2A
23	WASTE FILTER COMPLETE	9.8.2/20A
24	SPIGOT	8.8.3/2
25	WASTE BOSS	7.8.4/1
26	O RING	7.8.13
27	NUT	7.8.6
28	CLIP OF HOSE	7.4.12/4
29	WASTE HOSE - PUMP DRAIN	9.10.3/2
30	5mm TEE FOR AIR PRESSURE SWITCH	7.15.2/1
31	CLIP	7.4.12/8

December 2003 WO

H750 / H750NL / H7 FILTER SYSTEM

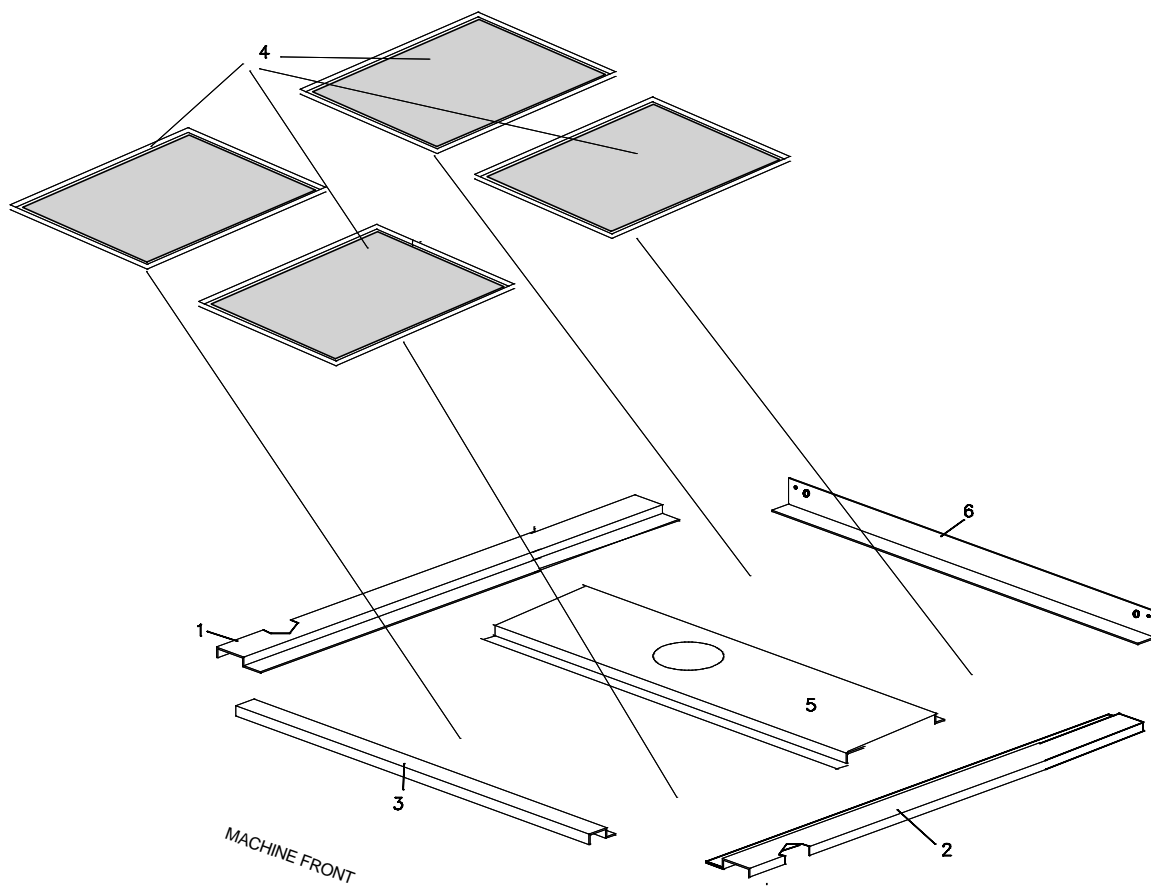

December 2003 WO

HYDRO 750 / 750 NL / H7

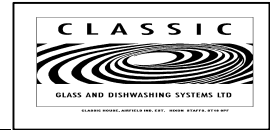

ITEM	DESCRIPTION	PART No
1	LEFT HAND SUPPORT FOR FILTERS	10.2.9/1
2	RIGHT HAND SUPPORT FOR FILTERS	10.2.9/2
3	FRONT SUPPORT FOR FILTERS	10.2.9/11
4	FILTER TRAY	10.2.9
5	CENTRE SUPPORT FOR FILTERS	10.2.9/10

December 2003 WO

STAINLESS STEEL TOP MODELS ONLY

ELECTRICAL PARTS

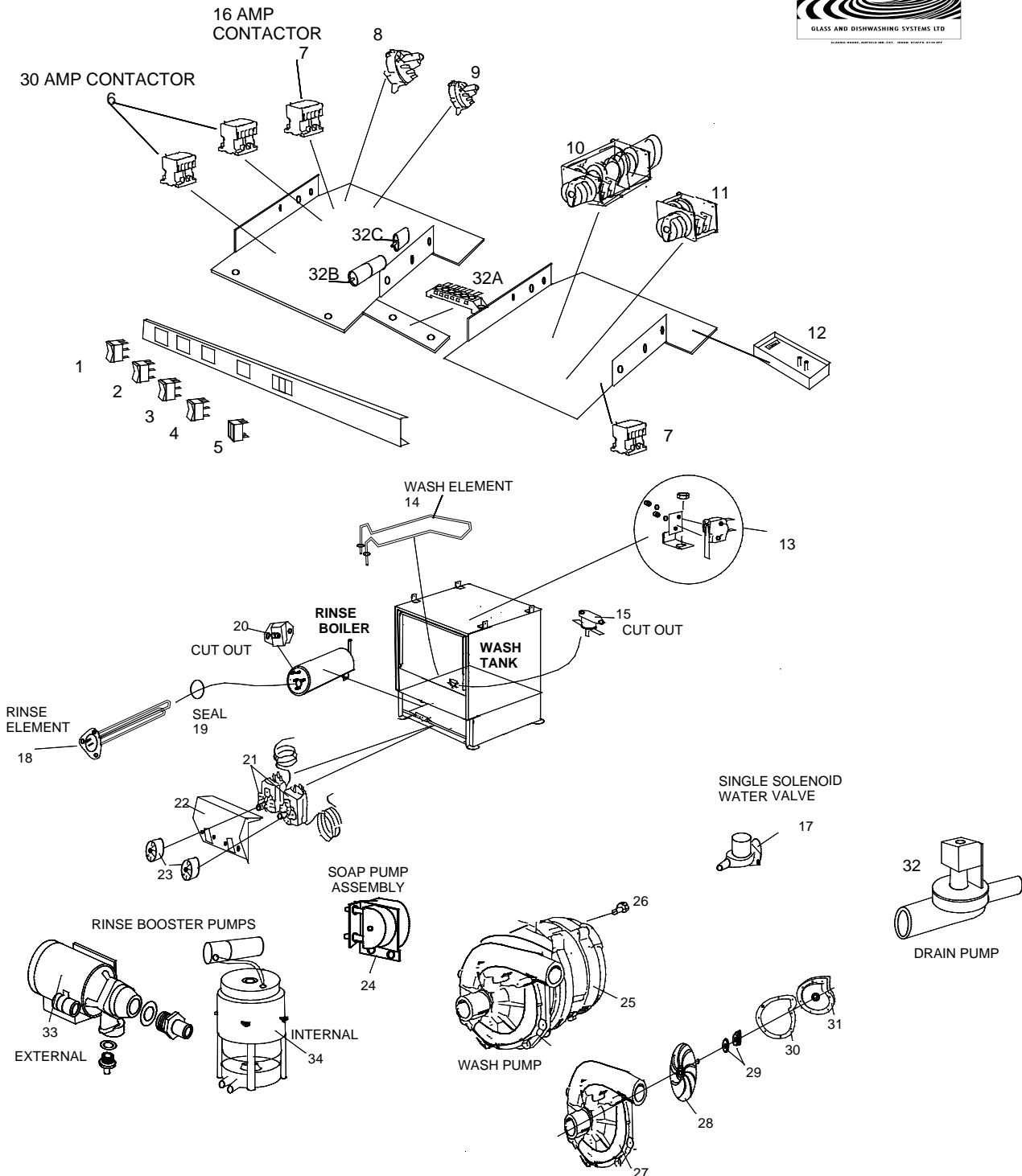

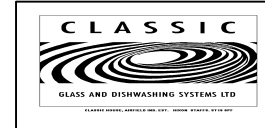

ELECTRICAL PARTS

HYDRO 750 STAINLESS STEEL TOP

ITEM	DESCRIPTION	PART No
1	ON / OFF SWITCH	7.12.4/B
2	WASH SWITCH	7.12.4/2A
3	DOMINO SWITCH	7.12.4/C
4	DRAIN SWITCH	7.12.4/2A
5	DOUBLE HEATER LIGHT	7.12.6/E
6	30 AMP CONTACTOR	CONTACTOR/12
7	16 AMP CONTACTOR	CONTACTOR/4
8	GREY PRESSURE SWITCH	7.12.9/E
9	SMALL PRESSURE SWITCH	7.12.9
10	2/4/MIN TIMER	7.12.2/2A
11	3 MIN DRAIN TIMER	7.12.2/5
12	SOAP PCB	CLM210
13	DOOR MICRO SWITCH ASS	7.12.10/1
14	WASH ELEMENT	9.12.17/2.5
15	WASH THERMAL CUTOUT	7.12.2/DS
N/S	THERMAL CUTOUT 4AMP	TCB-1
17	SINGLE WATER VALVE	7.12.12/1
18	RINSE ELEMENT 6kw	HY306
19	SEAL FOR RINSE ELEMENT	HY307
20	RINSE THERMAL CUTOUT	7.12.4/DX
21	THERMOSTAT	7.12.1/2
22	COVER FOR STATS	7.12.1/1A
23	KNOB	7.12.1/2A
24	SOAP PUMP	8LPP4AA
25	WASH PUMP	9.6.0/R
26	BOLT FOR MOTOR	7.6.15
27	HOUSING FOR PUMP	9.6.1/A
28	IMPELLOR	9.6.2
29	SEAL KIT FOR SHAFT	7.6.3
30	GASKET FOR HOUSING	9.6.13B
31	BACK PLATE	9.6.14B
32	DRAIN PUMP	DP2
32A	TERMINAL BLOCK	7.12.7/A
32B	CAPACITOR 12.5 mf	7.12.102
32C	RF SUPPRESSOR	7.12.101/A

RINSE BOOSTER PUMPS		
33	EXTERNAL RBP	DKRBP
34	INTERNAL RBP	RBP5
AIR BREAK TANK		
	FLOAT SWITCH CONTACTOR	7.12.11 CONTACTOR/4

December 2003 WO

H750 NEW LINE MACHINES

ELECTRICAL PARTS

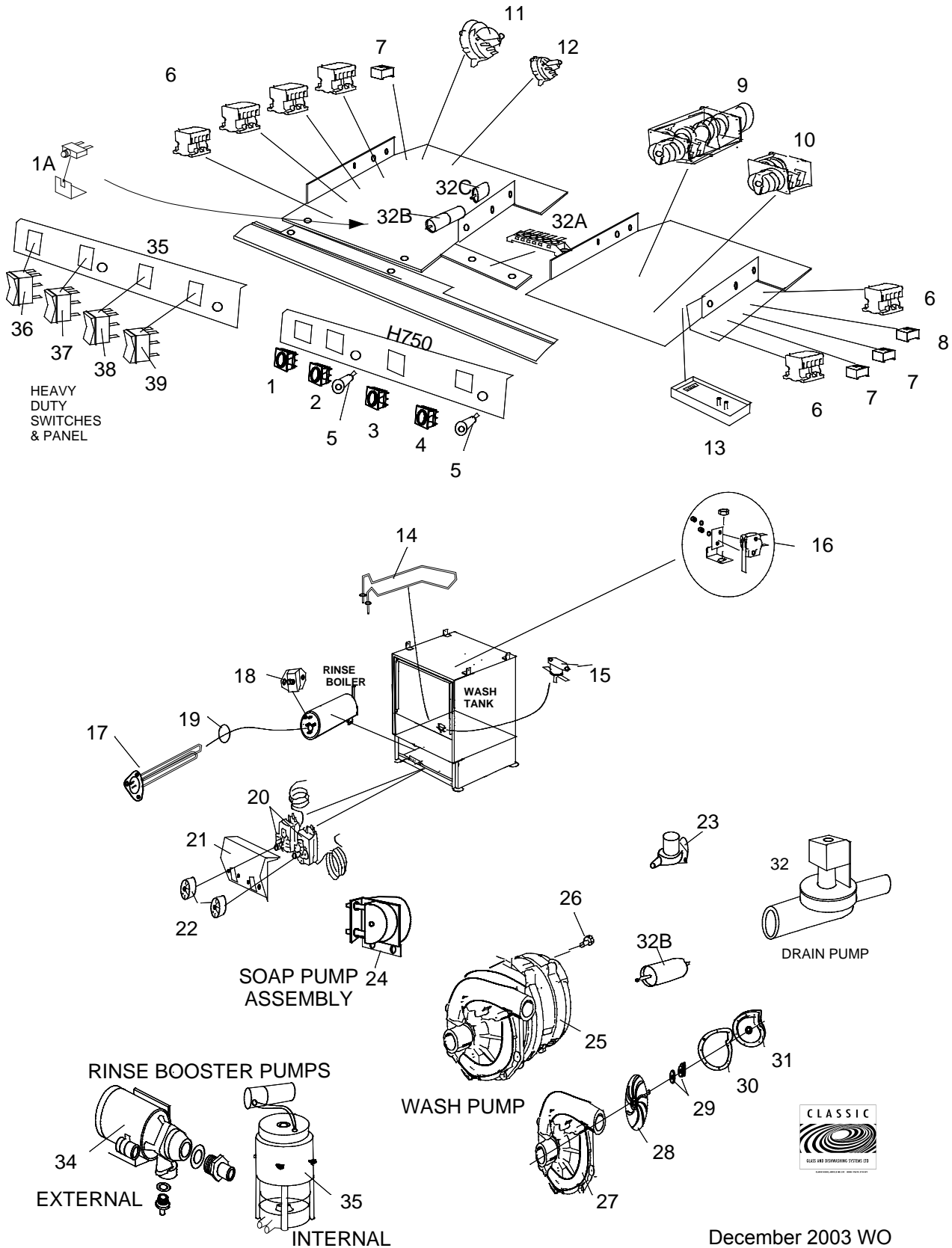

December 2003 WO

ELECTRICAL PARTS

NEW LINE

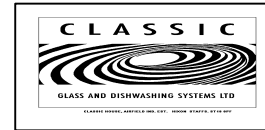

HYDRO 750 NEW LINE

ITEM	DESCRIPTION	PART No	
1	ON / OFF SWITCH	7.12.4/5	
1A	TCB 4 AMP CUTOUT	TCB-1	
2	MODE SWITCH	7.12.4/6	
3	DOMINO SWITCH	7.12.4/8A	
4	DRAIN SWITCH	7.12.4/7A	
5	NEON LIGHT	7.12.6/1A	
6	16 AMP CONTACTOR	CONTACTOR/4	
7	RELAY 4PIN	CONT/10	
8	RELAY 5PIN	CONT/11	
9	2 / 4 MIN TIMER	7.12.2/2A	
10	DRAIN TIMER	7.12.2/5	
11	GREY PRESSURE SWITCH	7.12.9/E	
12	SMALL PRESSURE SWITCH	7.12.9	
13	SOAP PCB	CLM210	
14	WASH ELEMENT	7.12.17/2.5	
15	WASH THERMAL CUTOUT	7.12.2/DS	
16	DOOR MICRO SWITCH	7.14.10/1	
17	RINSE ELEMENT 6kw	HY306	
18	RINSE THERMAL CUTOUT	7.12.4/D	
19	SEAL FOR RINSE ELEMENT	HY307	
20	THERMOSTAT	7.12.1/2	
21	COVER FOR STATS	7.12.1/1A	
22	KNOB	7.12.1/2A	
23	SINGLE WATER VALVE	7.12.12/1	
24	SOAP PUMP	8LPP4AA	
25	WASH PUMP	9.6.0/R	
26	BOLT FOR MOTOR	7.6.15	
27	HOUSING FOR PUMP	9.6.1/A	
28	IMPELLOR	9.6.2	
29	SEAL KIT FOR SHAFT	7.6.3	
30	GASKET FOR HOUSING	9.6.13B	
31	BACK PLATE	9.6.14B	
32	DRAIN PUMP	DP2	
32A	TERMINAL BLOCK	7.12.7/A	
32B	CAPACITOR 12mf	7.12.102	
32C	RF SUPPRESSOR	7.12.101/A	
RINSE BOOSTER PUMPS			
33	EXTERNAL RBP	DKRBP	
34	INTERNAL RBP	RBP5	
* 35	SPECIAL FACIA PANEL H750	10.2.2SX/2	*
* 36	ON/OFF SWITCH	7.12.4/21	*
* 37	MODE SWITCH	7.12.4/22	*
* 38	DOMINO SWITCH	7.12.4/24	*
* 39	DRAIN SWITCH	7.12.4/23	*
* 40	COMPETE SWITCH ASSEMBLY H750	ASS-04-009	*
AIR BREAK TANK			
	FLOAT SWITCH	7.12.11	
	CONTACTOR	CONTACTOR/4	

* Special Customer Livery Only

December 2003 WO

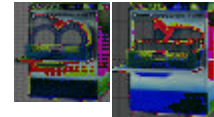

**H750 / H750NL / H7
WASH PUMPS**



Part No: 9.6.0/R
Black Wash Pump
For Remote Mounted Rinse-Aid
Pump

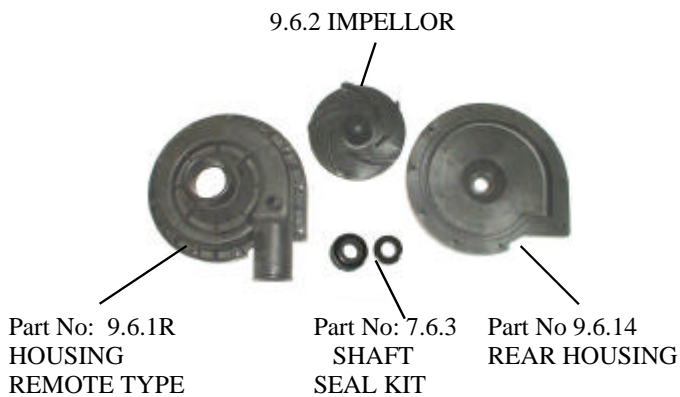

GASKET NOT SHOWN - 9.6.13B

from July 2001 Some Wash Pumps Are 'WHITE'
Machines with 'WHITE' WASH PUMPS have a
serial number starting with 8 eg 830254-212



Part No: 9.6.0/H
White Wash Pump
IHP
Used on machines with Serial Nos
starting with 8

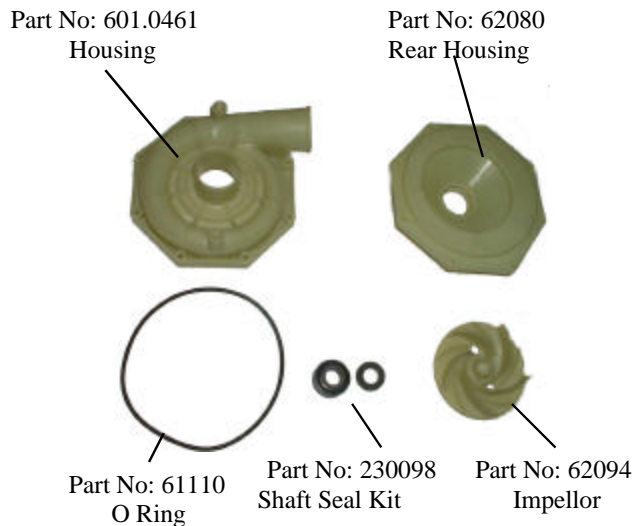

Check before you order !!

H750 / H750NL

INTERNAL AIR BREAK TANK

Item	Part No	Description
1	9.14.1	TANK
2	RBP4	RB PUMP - BRASS HEAD
	RBP5	RB PUMP - PLASTIC HEAD
3	7.12.11	FLOAT SWITCH
4	11.1.1/2E	ELBOW
5	7.5.9/2	O RING
6	7.3.13	NUT
7	9.14.2	COVER
8	7.10.2	BOSS
9	7.4.6	NUT
10	7.11.3	SEAL
11	9.15.104B	BRASS FITTING
12	9.15.101	ELBOW
13	7.8.14	HOSE - 1 Metre
14	7.4.12/1	CLIP FOR HOSE

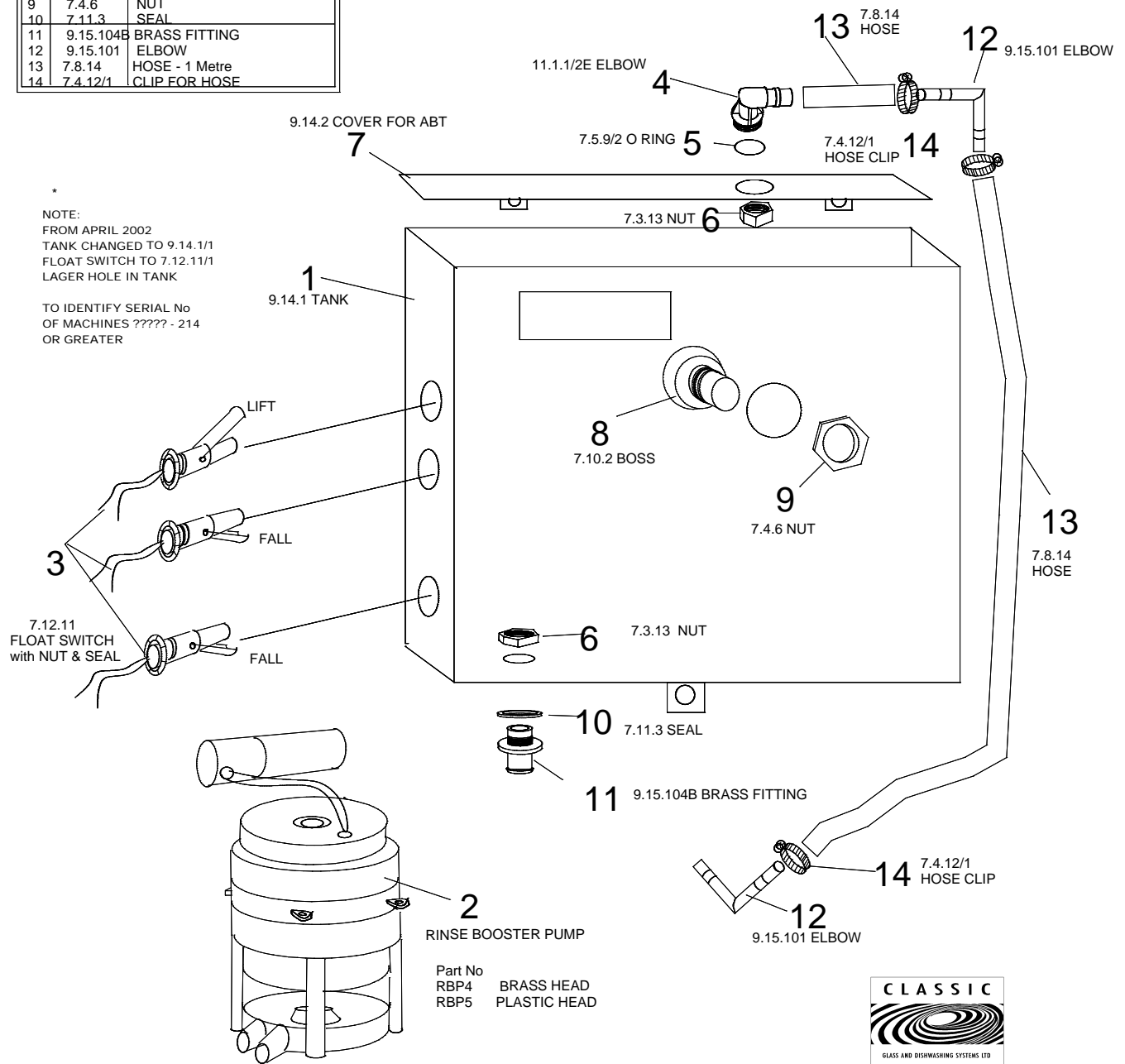

INTERNAL AIR BREAK TANK H750NL

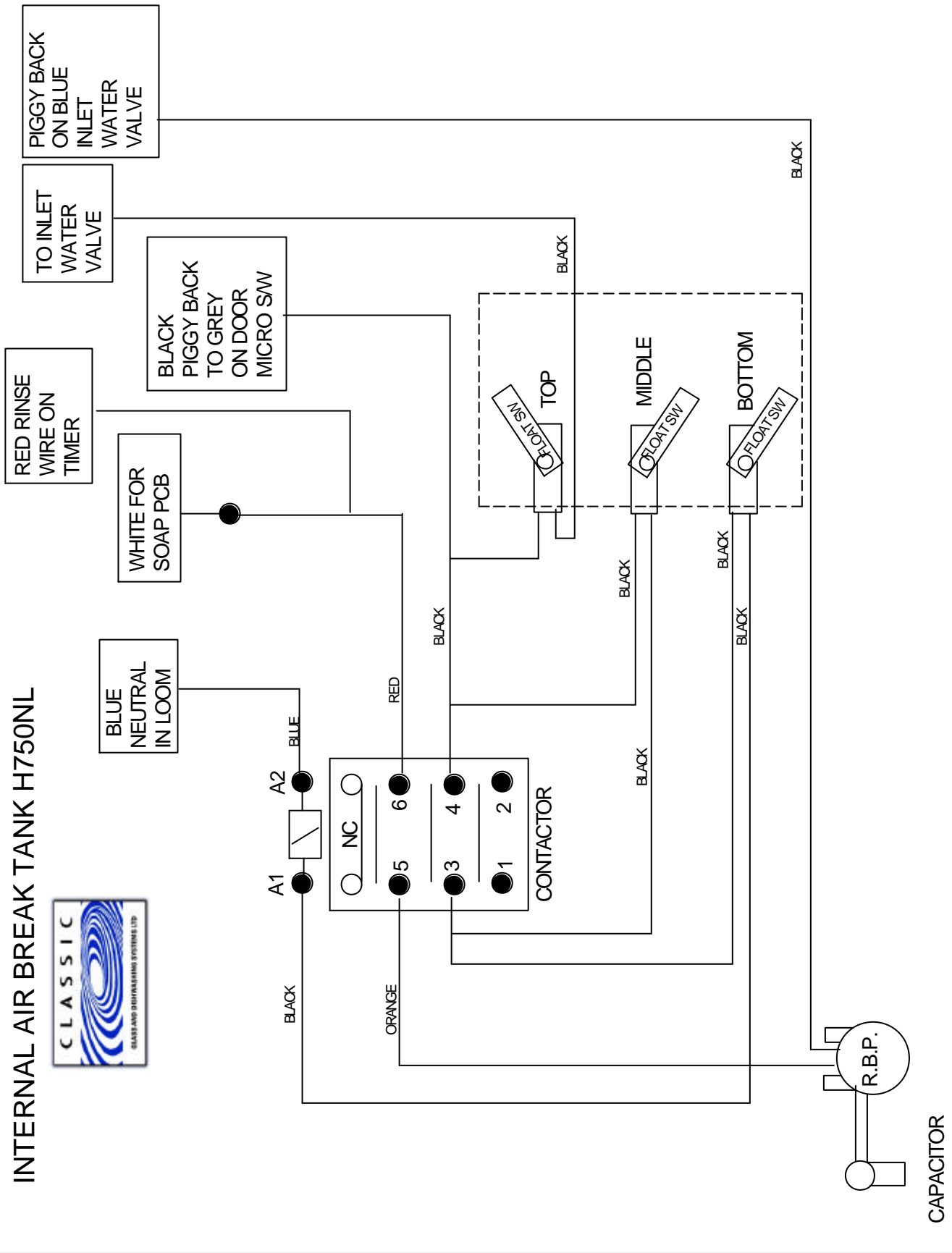

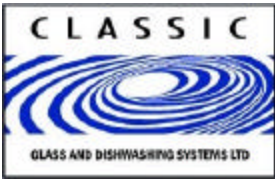

H750 DI SHWASHER 24 (H7) - 24 Volt DI SHWASHER
ELECTRICAL SPARE PARTS

All electrical items on this page are 24 volts
MOTORS — CONTACTOR /RELAY COILS — SWITCHES—WATER VALVE

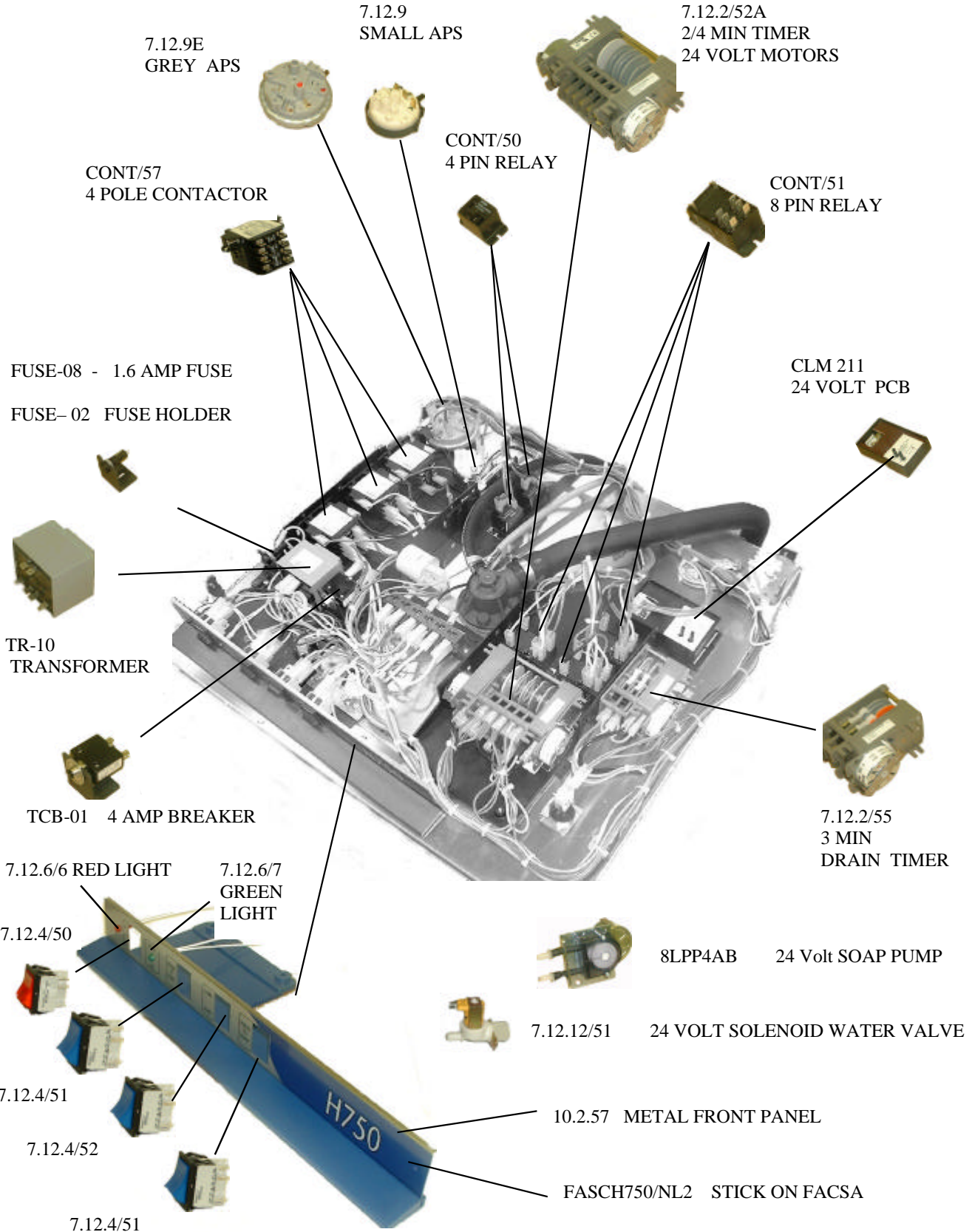

FOR ALL OTHER PARTS PLEASE REFER TO YOUR NORMAL MANUAL

December 2003 WO

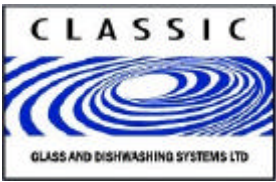

CLASSIC GLASS & DISHWASHING SYSTEMS LTD
 H7 - 24 Volt DISHWASHER
 ELECTRICAL SPARE PARTS AUGUST 2003

All electrical items on this page are 24 volts
 MOTORS — CONTACTOR /RELAY COILS — SWITCHES—WATER VALVE

Introduced August 2003 From Serial Number ?????- 332

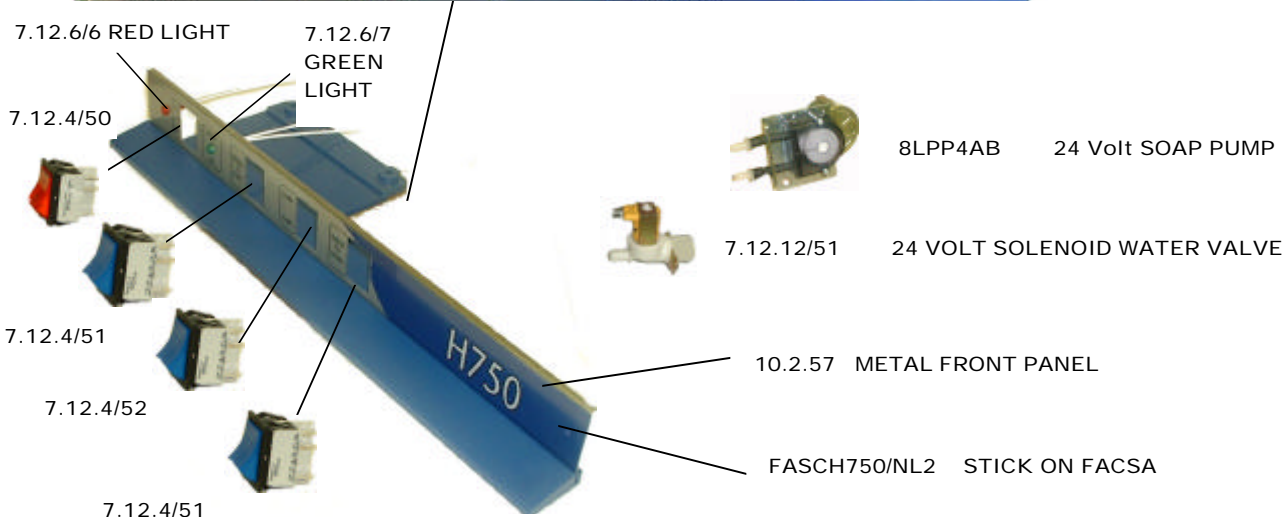
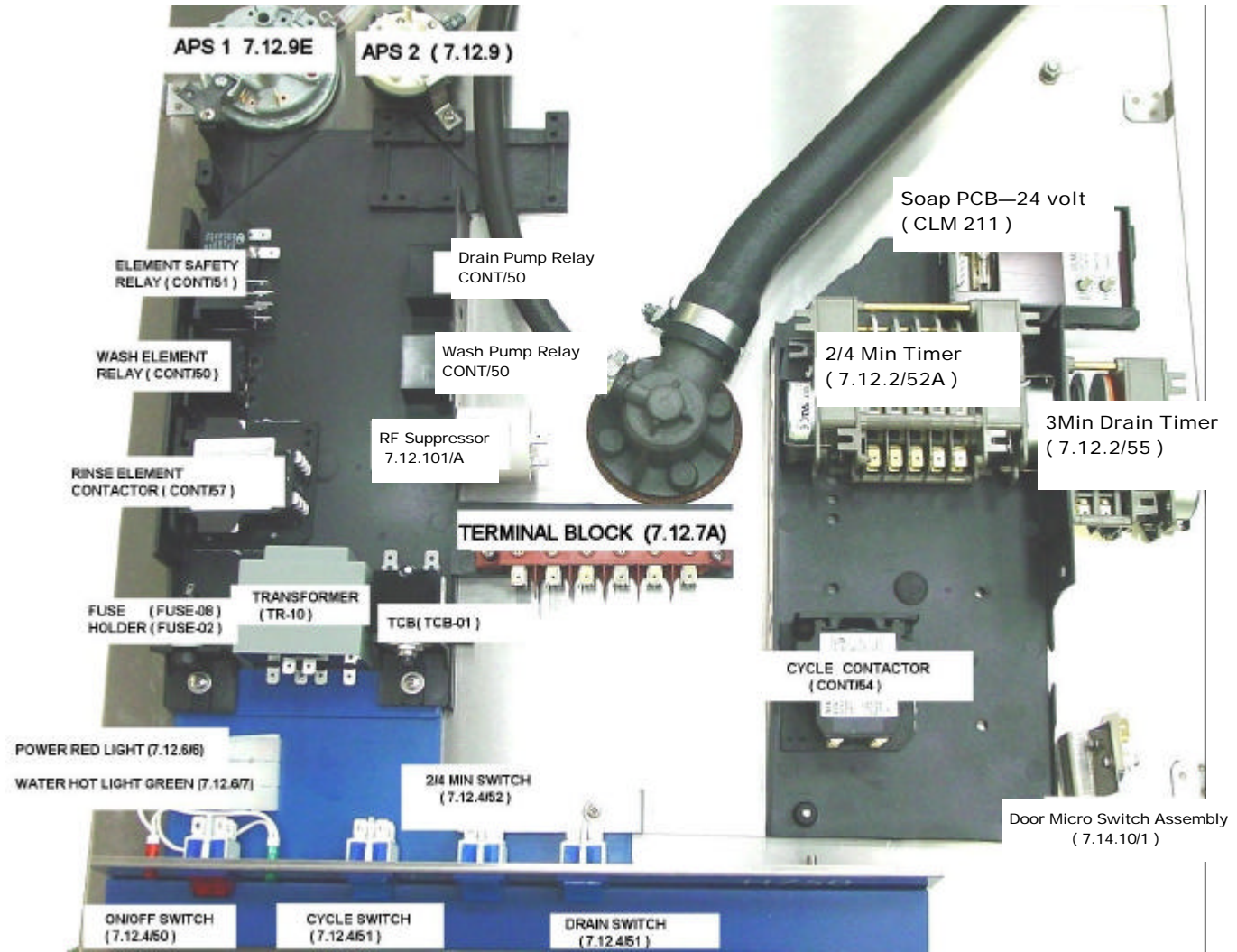

FOR ALL OTHER PARTS PLEASE REFER TO YOUR NORMAL MANUAL

TR-10



H7 DISHWASHER

This is interchangeable with the old type Transformer connect as below the only change is

The BLUE CABLE with BLACK SLEEVE is now 'piggy backed' onto BLACK CABLE on the

ON/OFF Switch

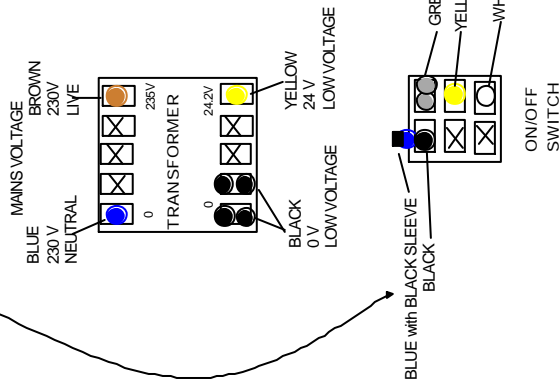

H750 (H7)



NEW CLEAR RELAY FITTED TO MACHINES From November 2003

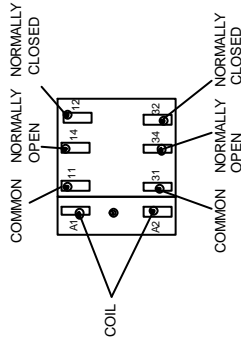

CONT/51A

FITTING RINSE BOOSTER PUMP To 24volt Classic Machine
 THESE CABLES ARE INSIDE THE LOWER PANEL OF THE MACHINE TO THE RIGHT HAND SIDE OF THE LOWER PANEL. DO NOT USE THE 'Orange' cable as it will NOT DO IT!

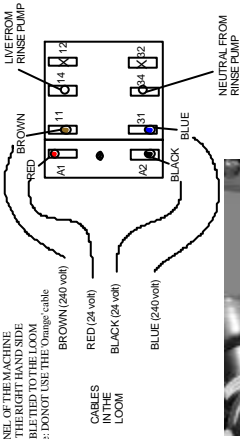

THE RELAY SHOULD REST ON THE SIDE RAIL NEAR THE SOAP PUMP.

AFTER ??-214 BEFORE ??- 328

H750 (H7)

LATCH RELAY CONT/51A

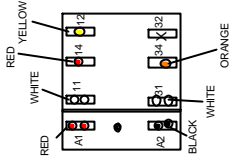

NOT USED

AFTER ??-328

H750 (H7)

CYCLE RELAY CONT/51A

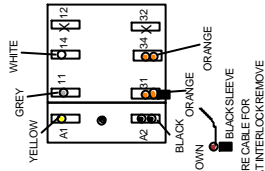

NOT USED

DOOR RELAY CONT/51A

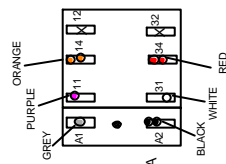

NOT USED

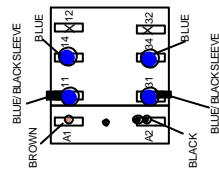

HEATER SAFETY RELAY - NEUTRAL

NEW CLEAR RELAY FITTED TO MACHINES From November 2003



SINGLE POLE RELAY CONT/50A

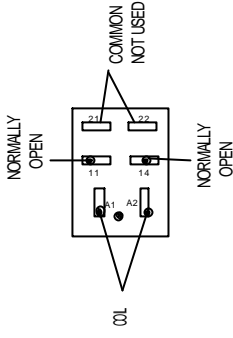

AFTER ??-328

H750 (H7)

WASH PUMP RELAY

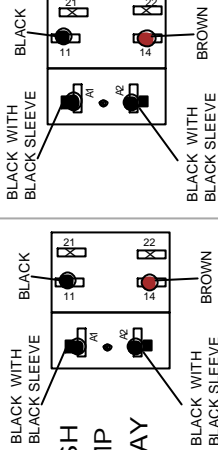

DRAIN PUMP RELAY

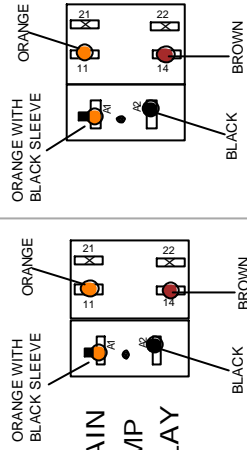

WASH ELEMENT RELAY

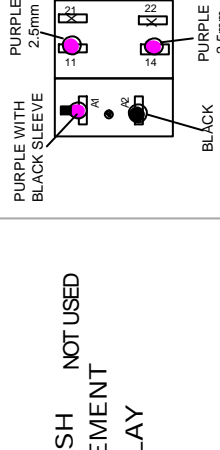

If replacing an old 'BLACK' type relay we supply terminals and cover sleeves. Note: YOU MUST FIT THESE TERMINALS WITH PROFESSIONAL CRIMP PLIERS

BLANK



CLASSIC H750 DRAWINGS



H750 DISHWASHER
Stainless Steel Top Machine
Introduced 1995
2—4 Minute Timer
No Drain Plug
3 Minute Drain Timer

H750 NL Dishwasher
New Line Dishwasher with
BLUE PLASTIC Top
Introduced 1998

Added Features
Heat interlock on 2 minute cycle
'Load it and leave it '



HYDRO 750 STAINLESS STEEL TOP WITH B9 CONTACTORS

- 1 - ON/OFF SWITCH
- 2 - START SWITCH
- 3 - WARNING LIGHT
- 4 - DOMINO SWITCH
- 5 - DRAIN SWITCH
- 7 - TERMINAL BLOCK
- 8 - SAFETY CONTACTOR
- 9 - BOILER CONTACTOR
- 10 - W/TANK CONTACTOR
- 11 - SMALL APS
- 13 - GREY APS
- 15 - SOAP PCB
- 16 - 2/4 MIN TIMER
- 17 - 3 MIN DRAIN TIMER
- 19 - DOOR CONTACTOR
- 22 - RINSE STAT
- 23 - WASH STAT
- 24 - DOOR MICRO SWITCH
- 25 - WASH PUMP
- 26 - INLET WATER SOLENOID
- 27 - THERMAL CUTOUT-WASH
- 29 - SOAP PUMP
- 30 - DRAIN PUMP
- 33 - WASH ELEMENT
- 34 - RINSE ELEMENT
- 36 - THERMAL CUTOUT-RINSE
- 37 - RF SUPPRESSOR
- 38 - CAPACTOR

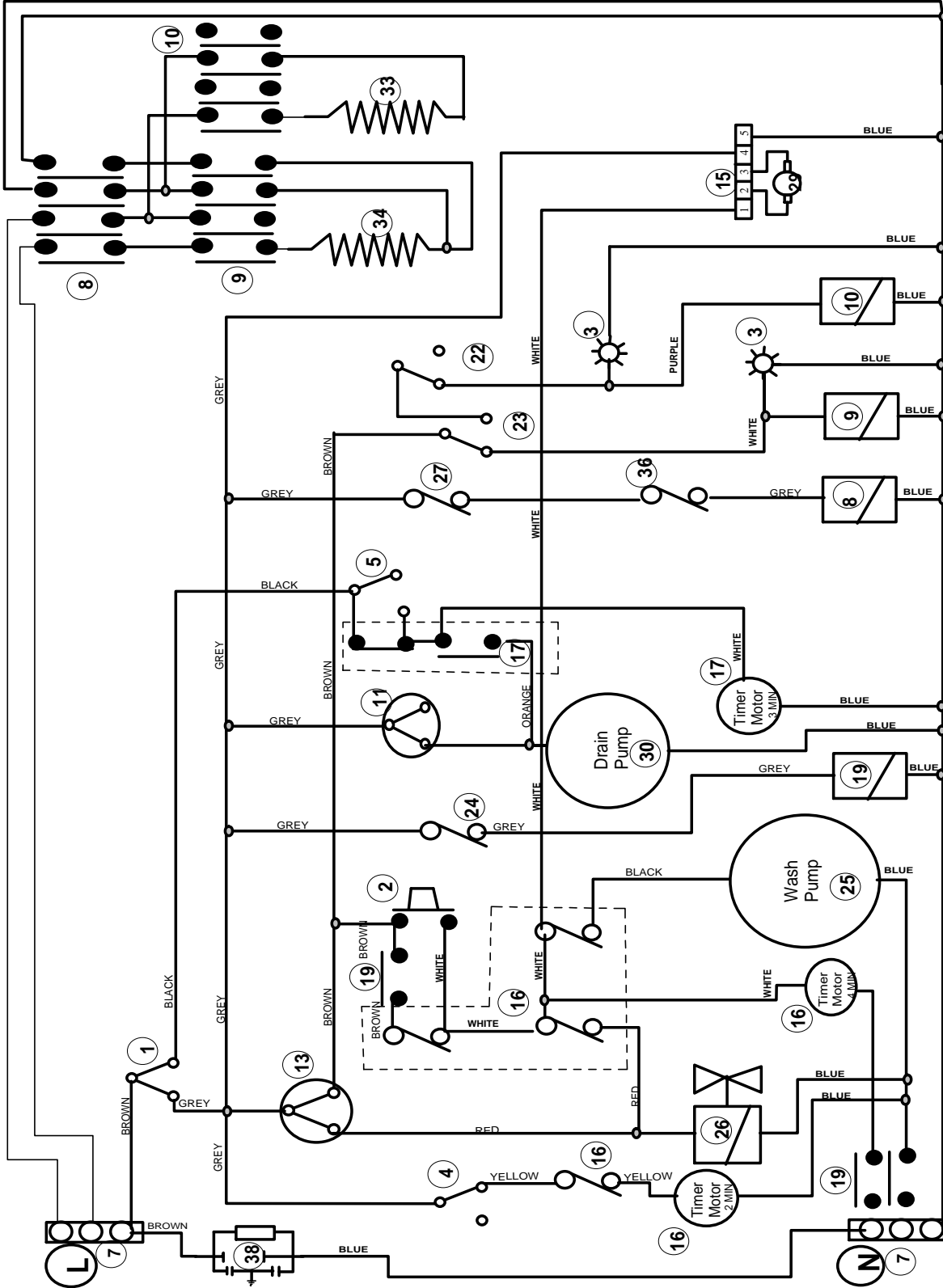

HYDRO 750 STAINLESS STEEL TOP WITH B6 CONTACTORS

- 1 - ON/OFF SWITCH
- 2 - START SWITCH
- 3 - WARNING LIGHT
- 4 - DOMINO SWITCH
- 5 - DRAIN SWITCH
- 7 - TERMINAL BLOCK
- 8 - SAFETY CONTACTOR-LIVE
- 8A - SAFETY CONTACTOR - NEUTRAL
- 9 - BOILER CONTACTOR
- 10 - W/TANK SAFETY CONTACTOR
- 10A - WASH TANK CONTACTOR
- 11 - SMALL APS
- 13 - GREY APS
- 15 - SOAP PCB
- 16 - 2/4 MIN TIMER
- 17 - 3 MIN DRAIN TIMER
- 19 - DOOR CONTACTOR
- 22 - RINSE STAT
- 23 - WASH STAT
- 24 - DOOR MICRO SWITCH
- 25 - WASH PUMP
- 26 - INLET WATER SOLENOID
- 27 - THERMAL CUTOUT-WASH
- 29 - SOAP PUMP
- 30 - DRAIN PUMP
- 33 - WASH ELEMENT
- 34 - RINSE ELEMENT
- 36 - THERMAL CUTOUT-RINSE
- 37 - RF SUPPRESSOR
- 38 - CAPACITOR

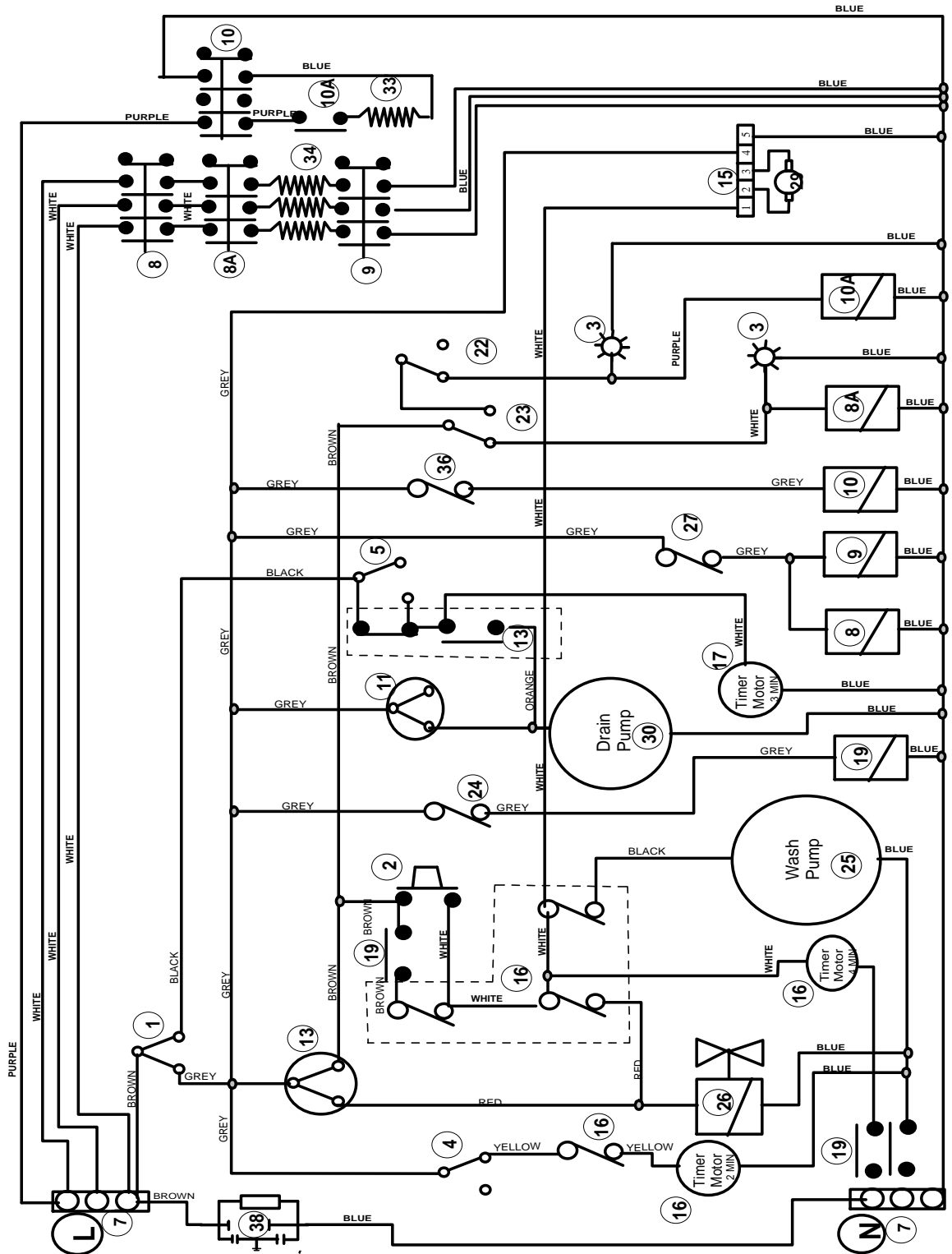

HYDRO 750 STAINLESS STEEL TOP DISHWASHER

TOP PANEL - COMPONENT WIRING

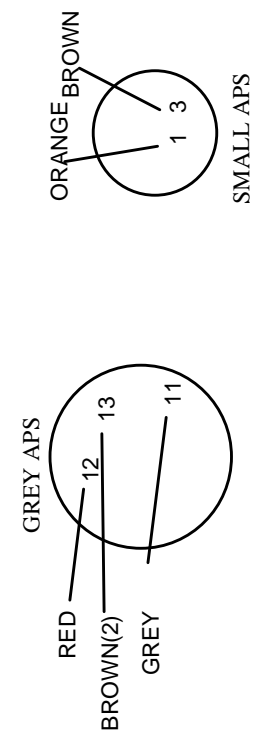
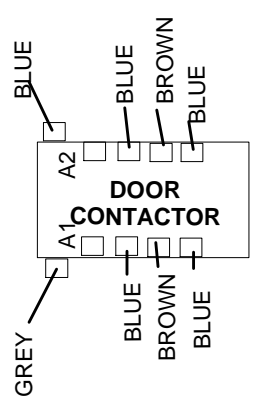
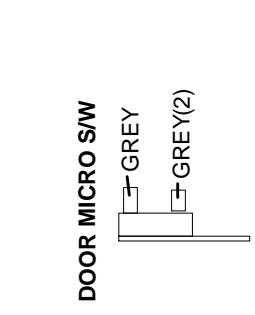
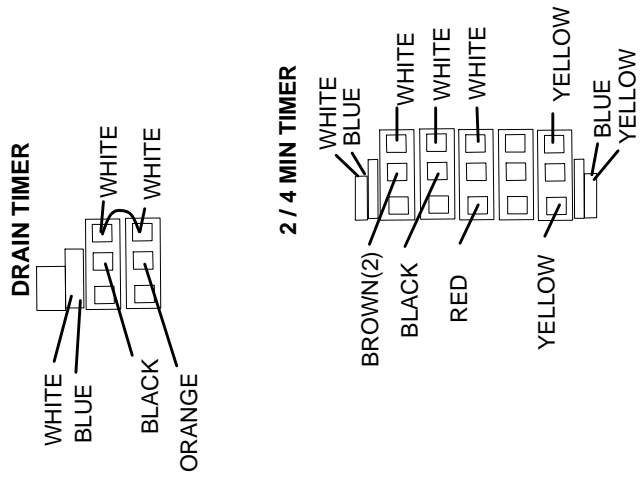
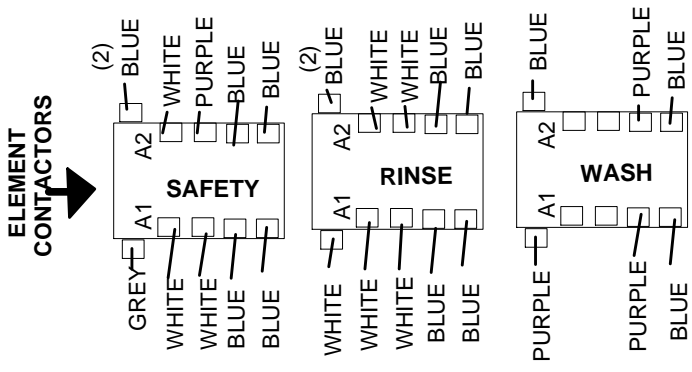
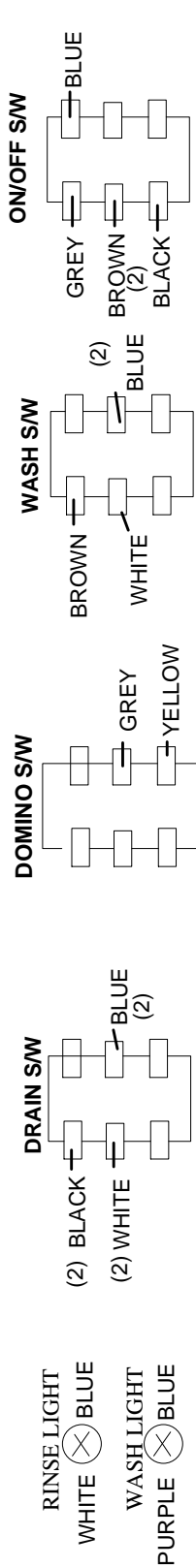

This drawing is not to scale

HYDRO 750 NEW LINE(BLUE TOP) PRIOR TO SERIAL NUMBER 19700

- B9 OR B12 CONTACTORS**
- 1 ON/OFF SWITCH
 - 2 MODE SWITCH
 - 3 READY LIGHT
 - 4 DOMINO SWITCH
 - 5 DRAIN SWITCH
 - 7 TERMINAL BLOCK
 - 8 SAFETY CONTACTOR
 - 9 RINSE CONTACTOR
 - 10 SAFETY CONTACTOR
 - 13 GREY APS
 - 15 CAPACITOR
 - 16 2/4 MIN TIMER
 - 17 DRAIN TIMER
 - 19 DOOR CONTACTOR
 - 20 MODE RELAY
 - 21 LATCH RELAY
 - 22 TIMER RELAY
 - 23 LOGIC CONTACTOR
 - 24 DOOR MICRO SWITCH
 - 25 WASH PUMP
 - 26 INLET WATER SOLENOID
 - 27 THERMAL CUTOFF WASH
 - 29 SOAP PUMP
 - 30 DRAIN PUMP
 - 31 RINSE STAT
 - 32 WASH STAT
 - 33 ELEMENT WASH
 - 34 ELEMENT RINSE
 - 36 THERMAL CUTOFF RINSE
 - 38 RF SUPPRESSOR

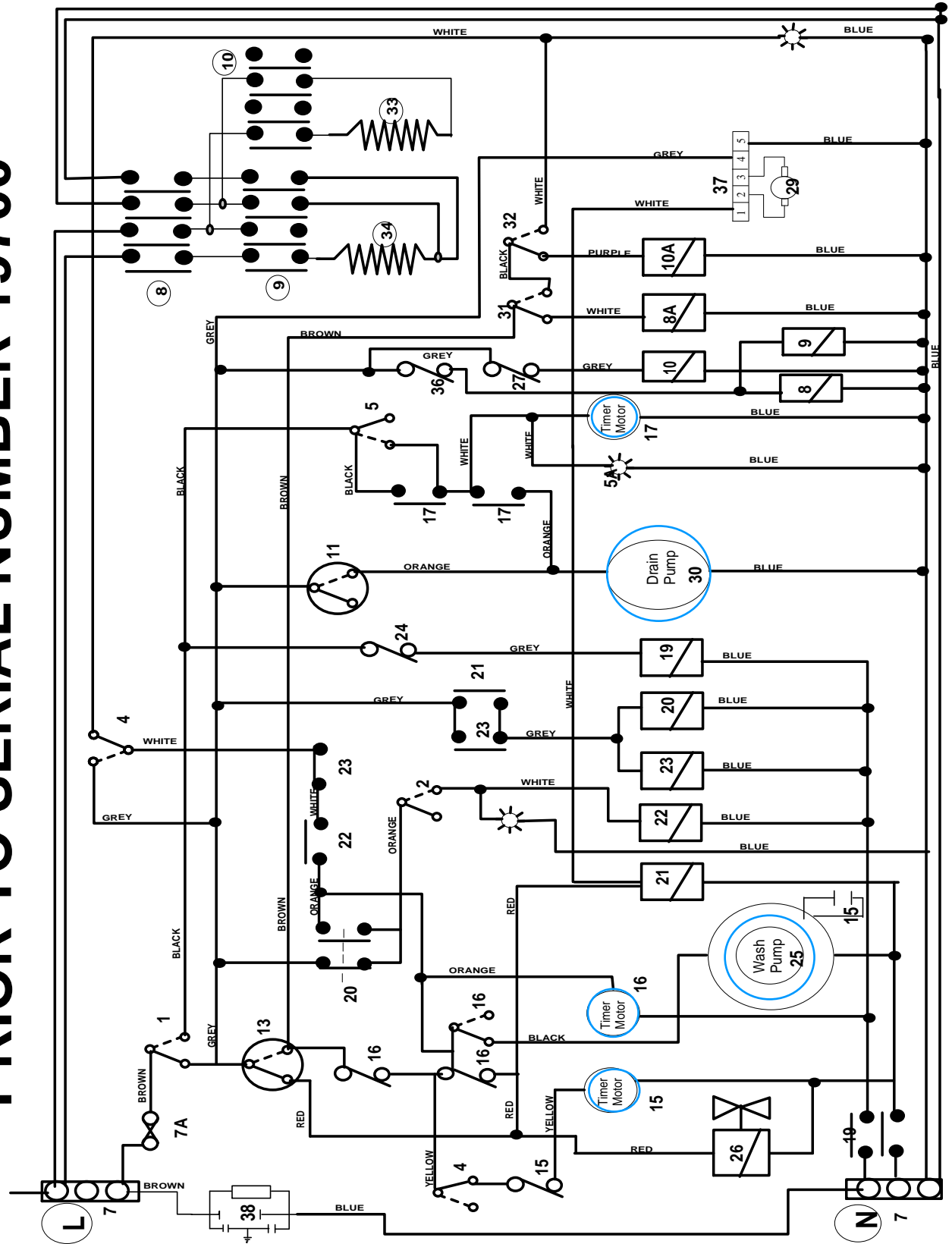

HYDRO 750 NEW LINE(BLUE TOP) AFTER SERIAL NUMBER 19701 PRIOR TO ?? - 811

- 1 ON/OFF SWITCH
- 2 MODE SWITCH
- 3 READY LIGHT
- 4 DOMINO SWITCH
- 5 DRAIN SWITCH
- 7 TERMINAL BLOCK
- 8 SAFETY CONTACTOR - RINSE - LIVE
- 8A SAFETY CONTACTOR - RINSE - NEUTRAL
- 9 RINSE CONTACTOR
- 10 SAFETY CONTACTOR - WASH
- 10A WASH ELEMENT - CONTACTOR
- 11 SMALL APS
- 13 GREY APS
- 15 CAPACITOR
- 16 2/4 MIN TIMER
- 17 3 MIN DRAIN TIMER
- 19 DOOR CONTACTOR
- 20 MODE RELAY
- 21 LATCH RELAY
- 22 TIMER RELAY
- 23 LOGIC CONTACTOR
- 24 DOOR MICRO SWITCH
- 25 WASH PUMP
- 26 INLET SOLENOID VALVE
- 27 THERMAL CUTOUT-WASH
- 29 SOAP PUMP
- 30 DRAIN PUMP
- 31 RINSE STAT
- 32 WASH STAT
- 33 ELEMENT - WASH
- 34 ELEMENT RINSE
- 36 THERMAL CUTOUT - RINSE
- 38 RE SUPPRESSOR

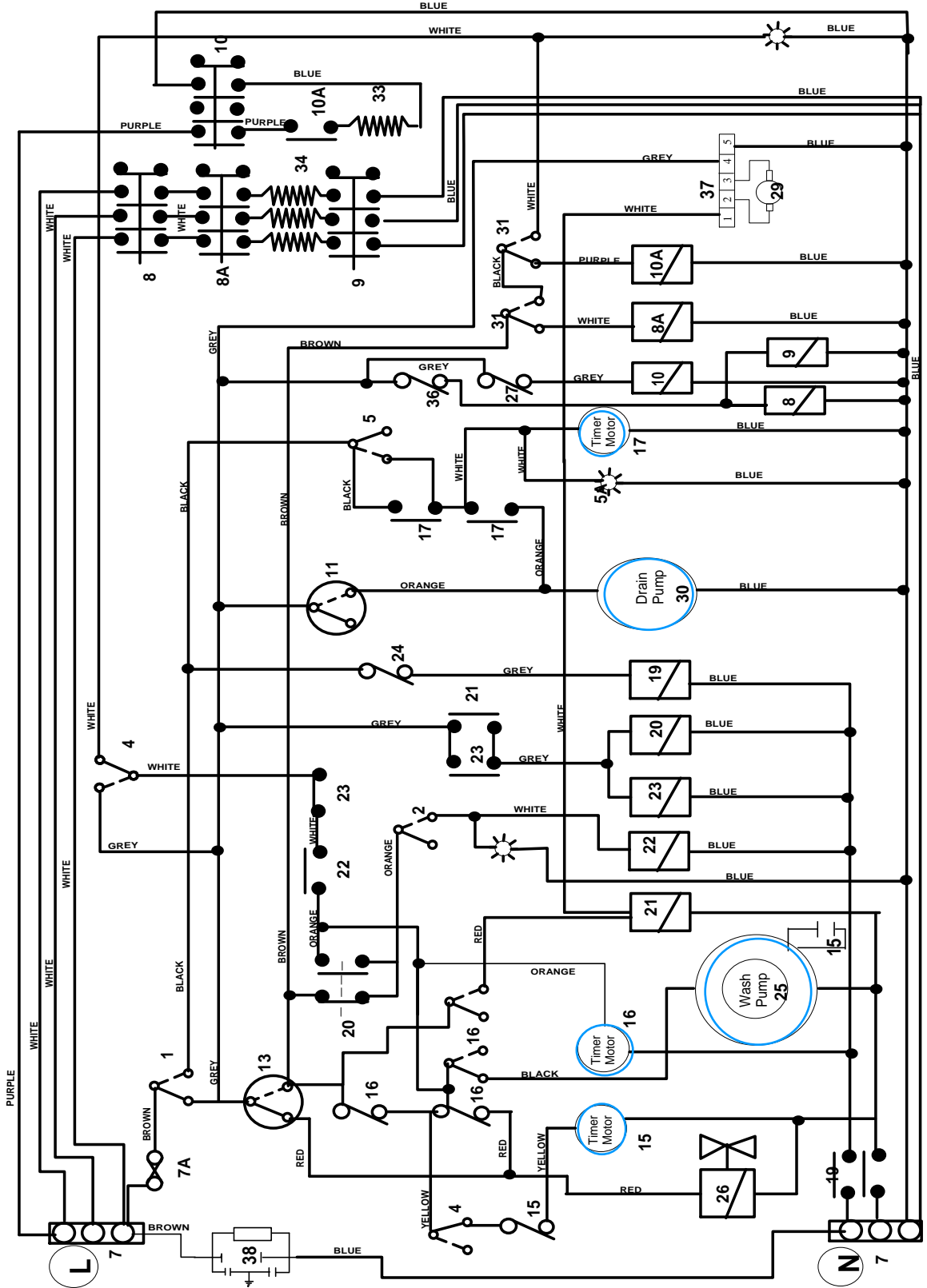

HYDRO 750 NEW LINE(BLUE TOP) AFTER SERIAL NO ??-811 TO ?? - 909

- 1 ON/OFF SWITCH
- 2 MODE SWITCH
- 3 READY LIGHT
- 4 DOMINO SWITCH
- 5 DRAIN SWITCH
- 7 TERMINAL BLOCK
- 8 SAFETY CONTACTOR
- 8A SAFETY CONTACTOR - RINSE - LIVE
- 9 SAFETY CONTACTOR - RINSE - NEUTRAL
- 10 RINSE CONTACTOR
- 10 SAFETY CONTACTOR - WASH
- 10A WASH ELEMENT
- CONTACTOR
- 11 SMALL APS
- 13 GREY APS
- 15 CAPACITOR
- 16 2/4 MIN TIMER
- 17 3 MIN DRAIN TIMER
- 19 DOOR CONTACTOR
- 20 MODE RELAY
- 21 LATCH RELAY
- 22 TIMER RELAY
- 23 LOGIC CONTACTOR
- 24 DOOR MICRO SWITCH
- 25 WASH PUMP
- 26 INLET SOLENOID VALVE
- 27 THERMAL CUTOUT-WASH
- 29 SOAP PUMP
- 30 DRAIN PUMP
- 31 RINSE STAT
- 32 WASH STAT
- 33 ELEMENT - WASH
- 34 ELEMENT RINSE
- 36 THERMAL CUTOOUT - RINSE
- 38 RE SUPPRESSOR

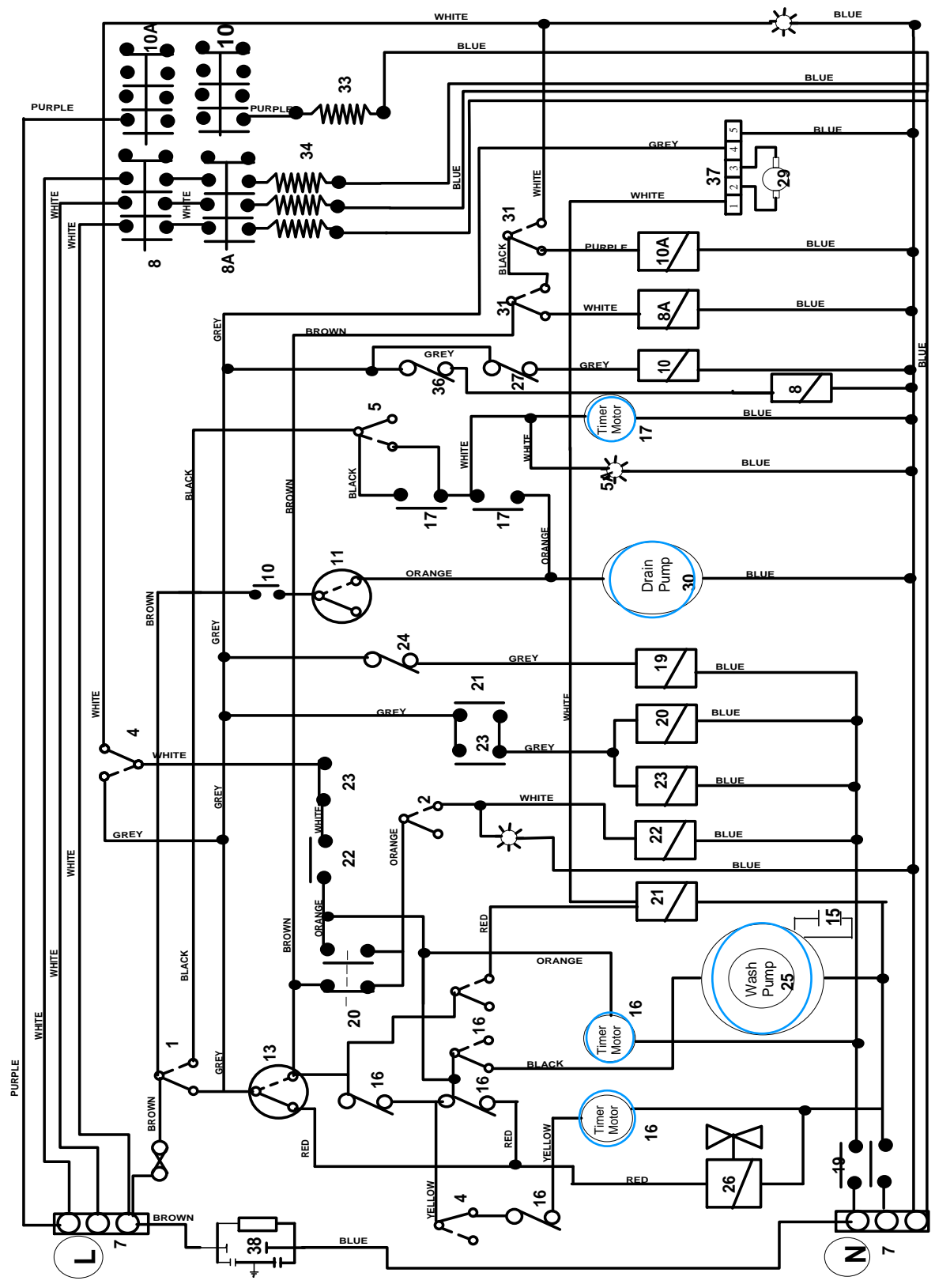

HYDRO 750 NEW LINE(BLUE TOP) AFTER SERIAL NO ??-909 TO ??-215

- 1 ON/OFF SWITCH
- 2 MODE SWITCH
- 3 READY LIGHT
- 4 DOMINO SWITCH
- 5 DRAIN SWITCH
- 7 TERMINAL BLOCK
- 8 SAFETY CONTACTOR - RINSE - LIVE
- 8A SAFETY CONTACTOR - RINSE - NEUTRAL
- 9 RINSE CONTACTOR
- 10 SAFETY CONTACTOR - WASH
- 10A WASH ELEMENT - CONTACTOR
- 11 SMALL APS
- 13 GREY APS
- 15 CAPACITOR
- 16 2/4 MIN TIMER
- 17 3 MIN DRAIN TIMER
- 19 DOOR CONTACTOR
- 20 MODE RELAY
- 21 LATCH RELAY
- 22 TIMER RELAY
- 23 LOGIC CONTACTOR
- 24 DOOR MICRO SWITCH
- 25 WASH PUMP
- 26 INLET SOLENOID VALVE
- 27 THERMAL CUTOUT-WASH
- 29 SOAP PUMP
- 30 DRAIN PUMP
- 31 RINSE STAT
- 32 WASH STAT
- 33 ELEMENT - WASH
- 34 ELEMENT RINSE
- 36 THERMAL CUTOUT - RINSE
- 37 PCB - SOAP
- 38 RE SUPPRESSOR

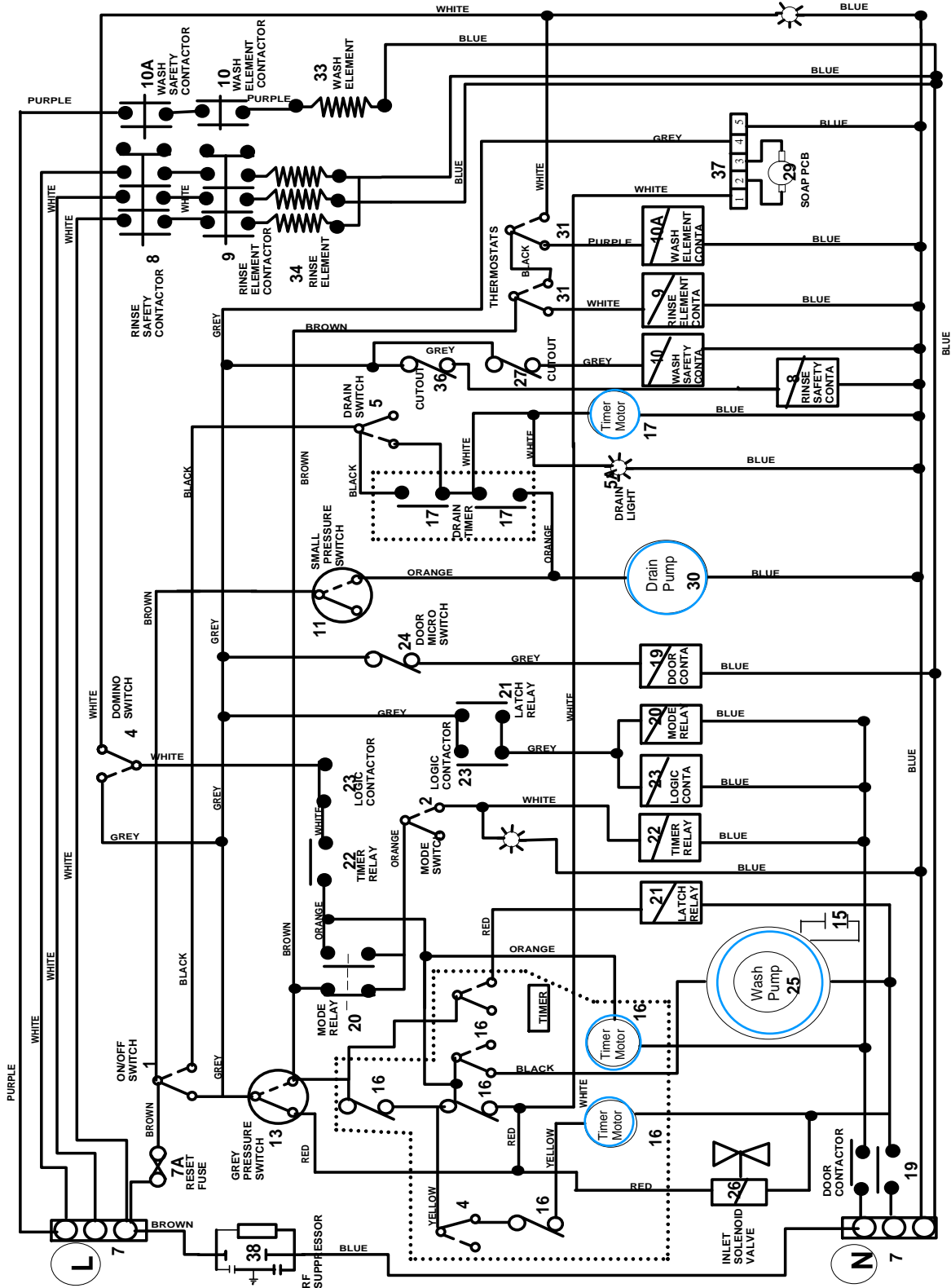
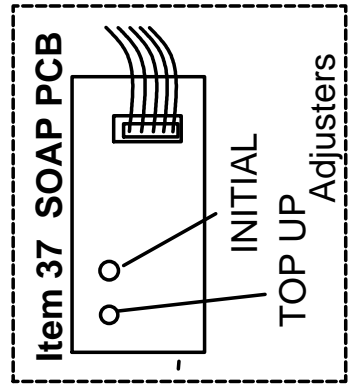

HYDRO 750 NEW LINE (Blue Top) DISHWASHER TOP PANEL - COMPONENT WIRING

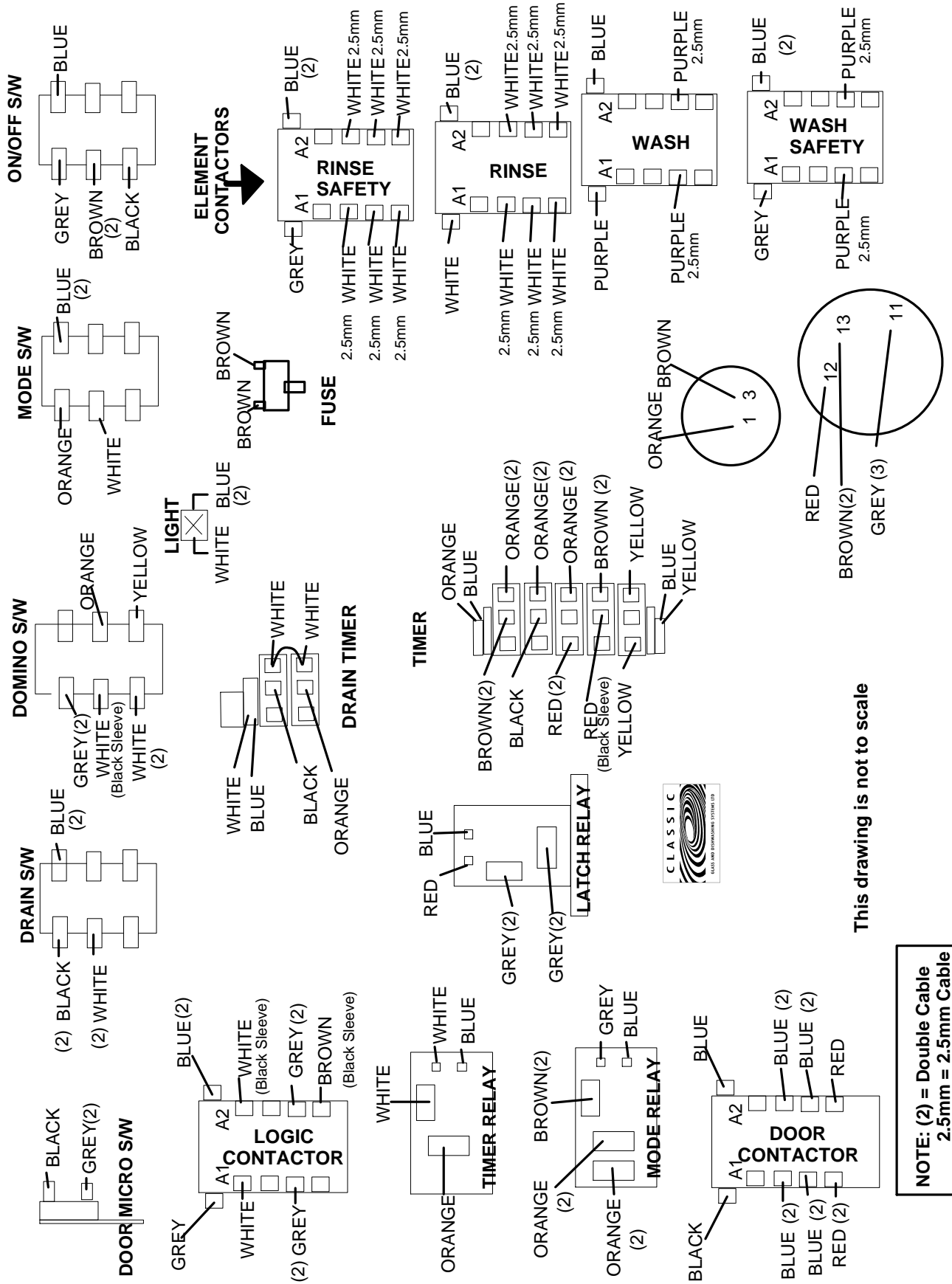

This drawing is not to scale

NOTE: (2) = Double Cable
2.5mm = 2.5mm Cable



CLASSIC GLASS & DISHWASHING SYSTEMS LTD

H750 ONLY
INTERLOCK WASH CYCLE
START POSITION

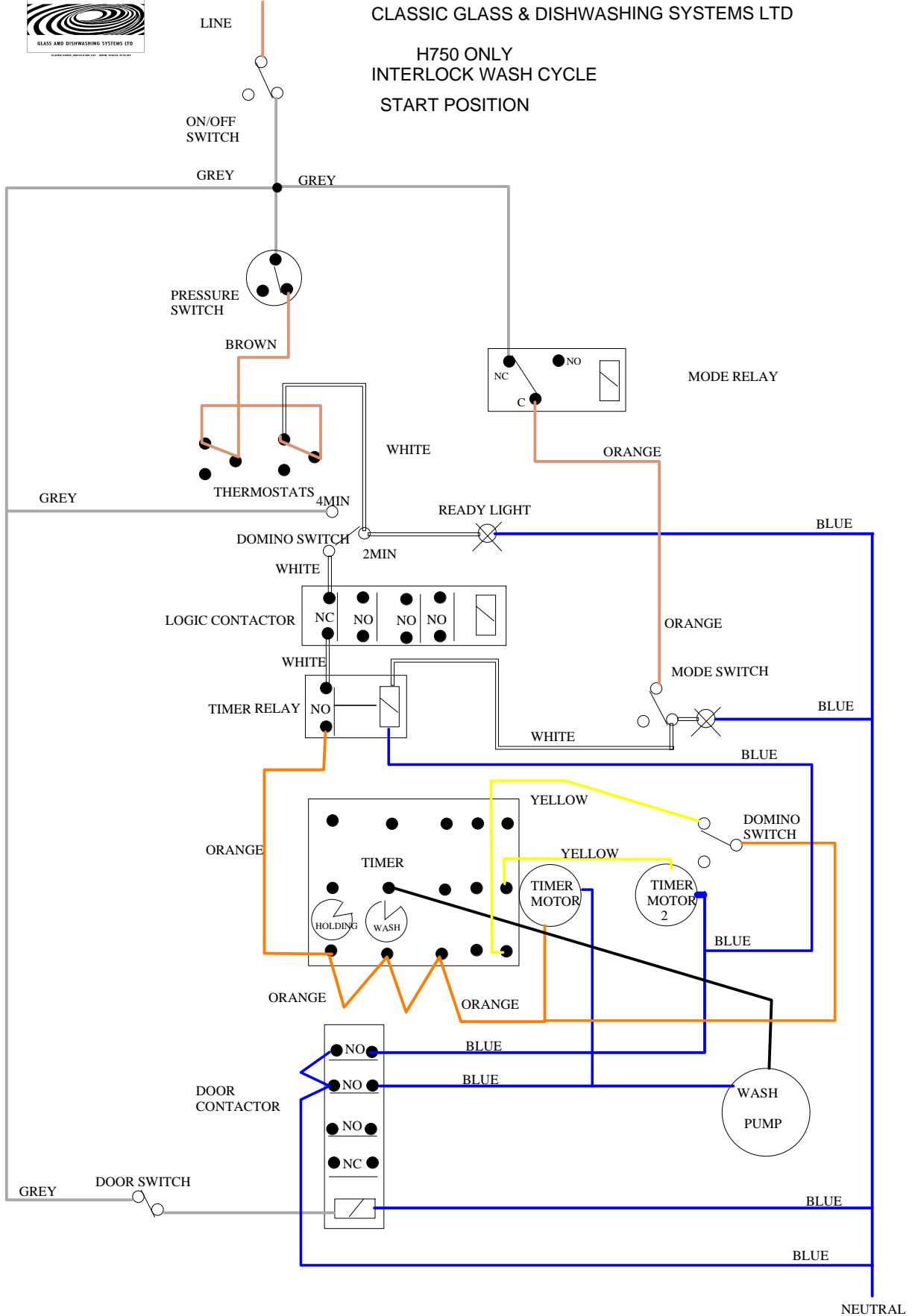



CLASSIC GLASS & DISHWASHING SYSTEMS LTD

H750 NL
INTERLOCK - CHANGEOVER CYCLE

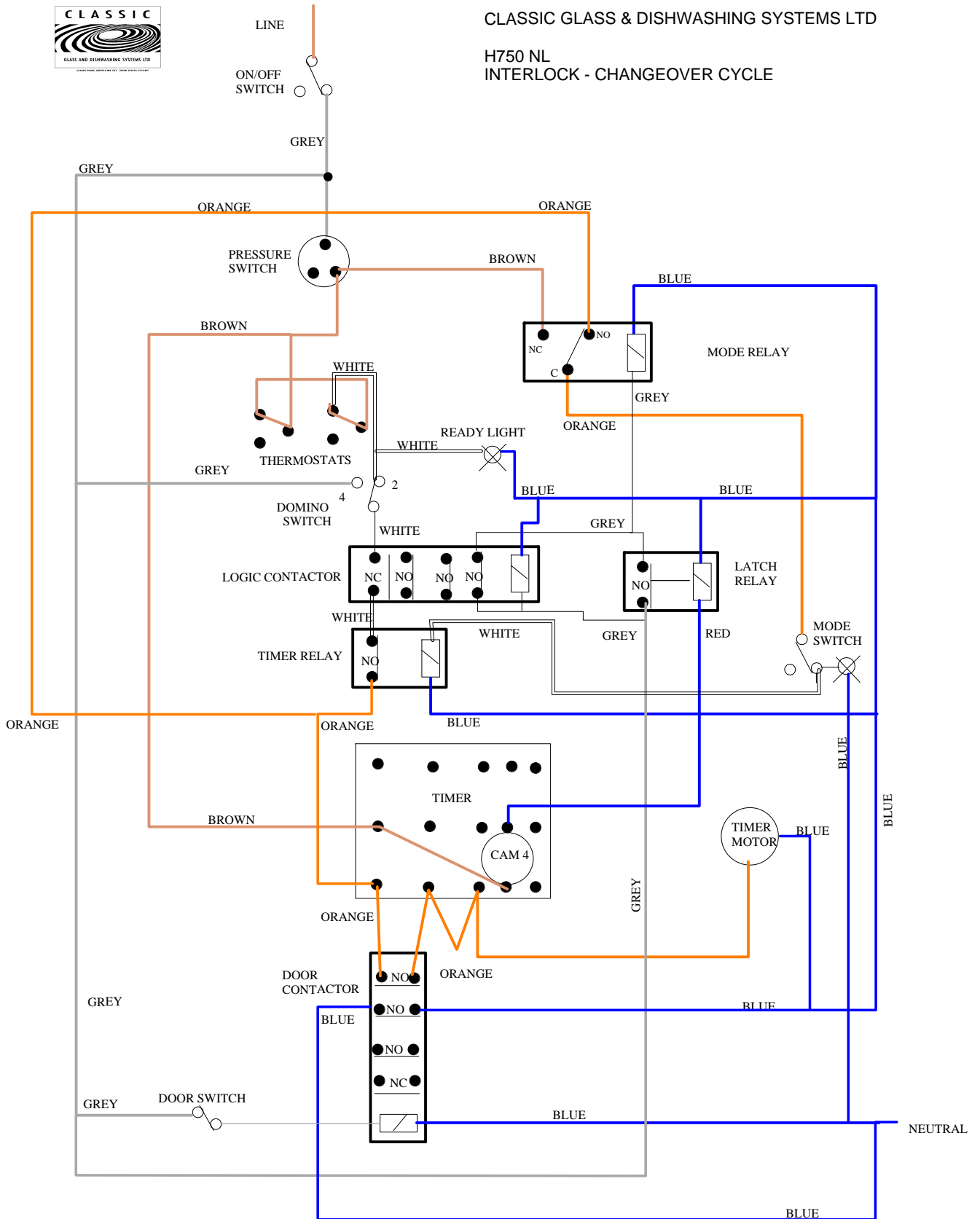



CLASSIC 24 VOLT RANGE

24 VOLT RANGE INTRODUCED APRIL 2002

ALL THE UNIQUE PARTS FOR :

H7 (H750) DISHWASHER



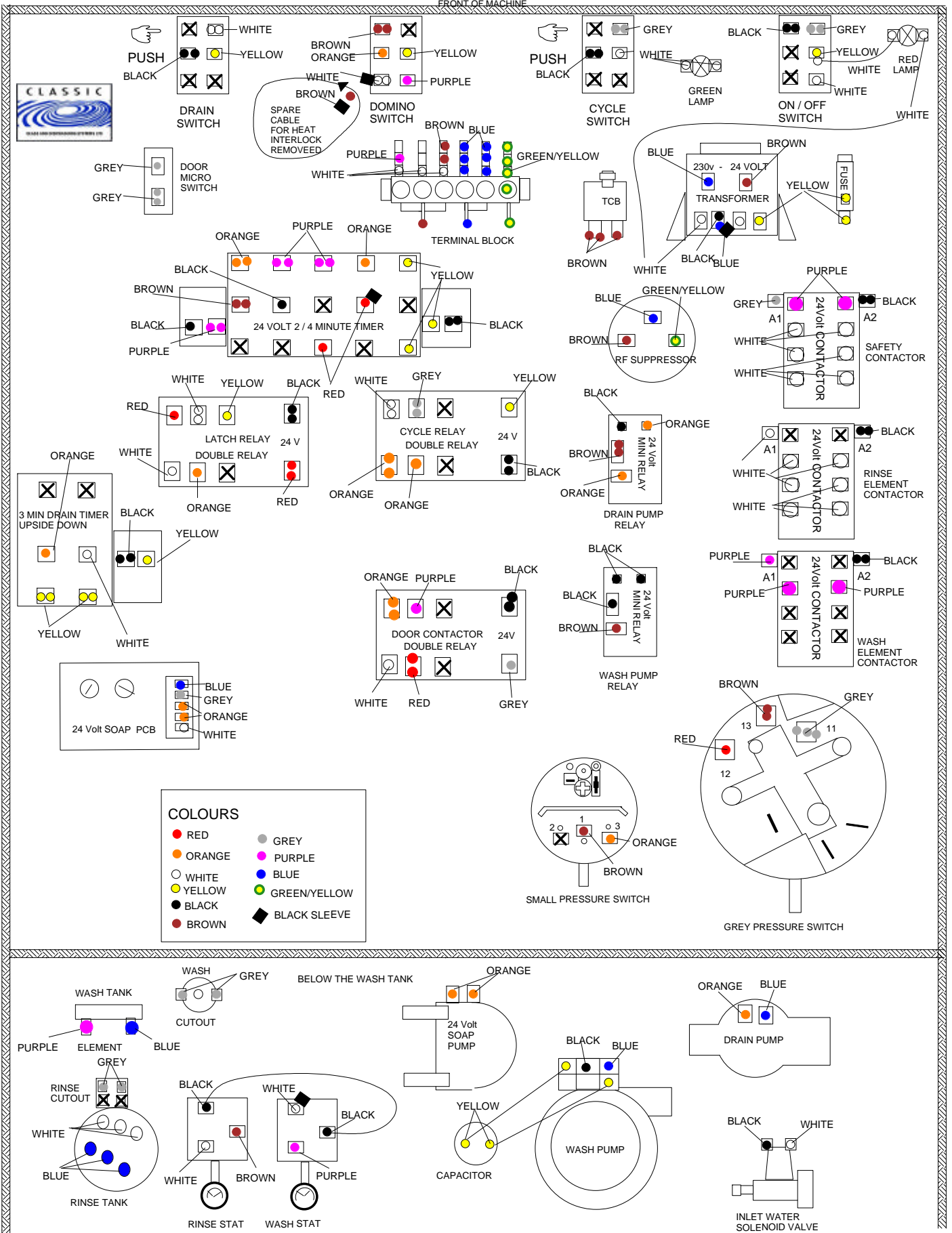

CLASSIC 24 - H7 DISHWASHER ISSUE 1 FROM Serial No ???-214 TO ???-241

September 2003 WO

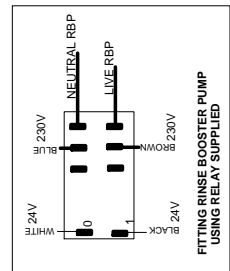
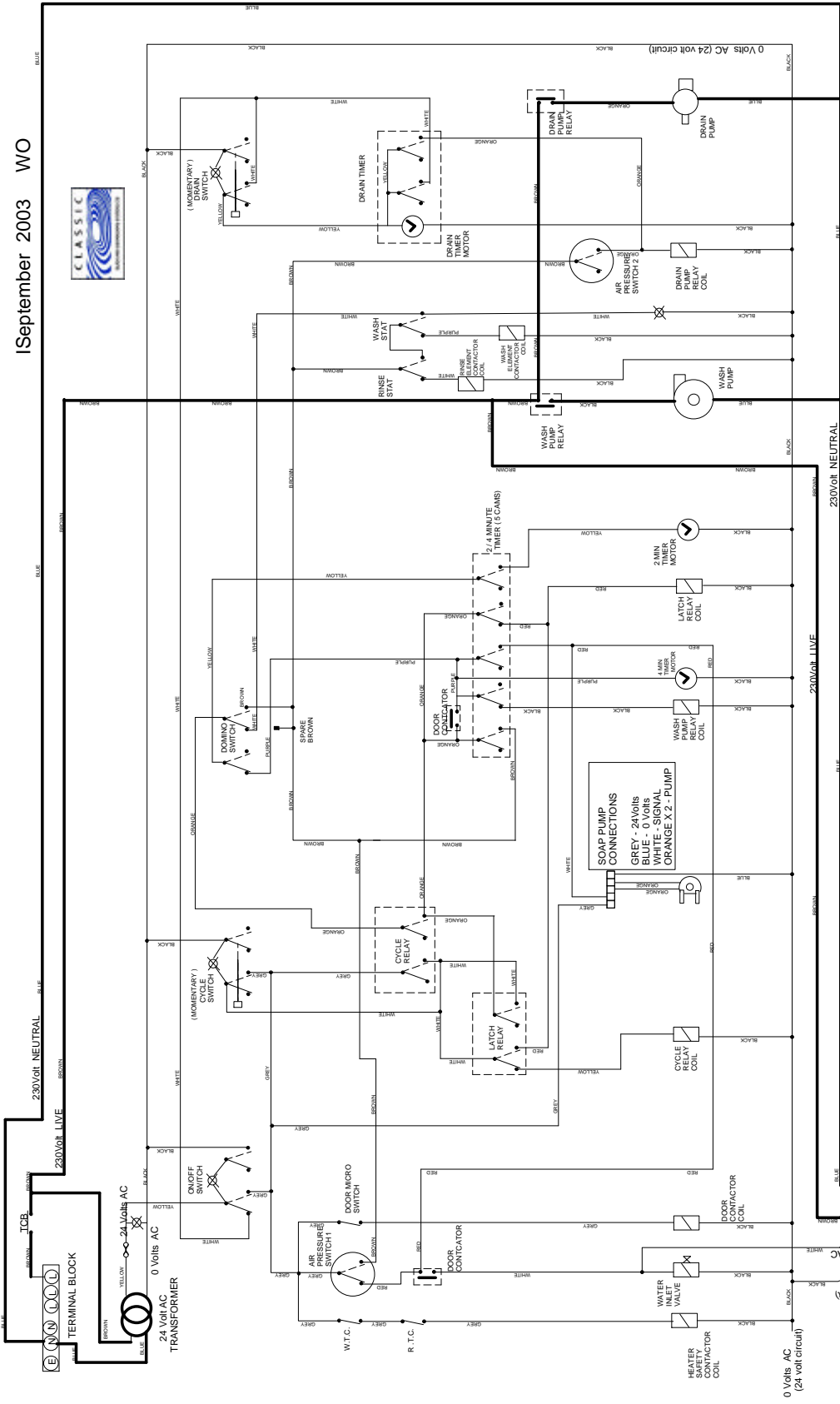

Part No: CONT/51 24 VOLT RELAY

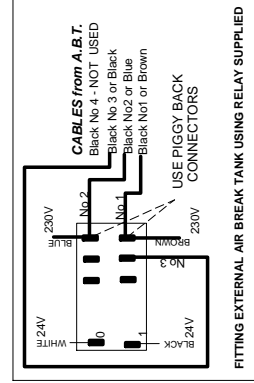

CABLES from A.B.T.
 Black No 4 - NOT USED
 Black No 3 or Black
 Black No 2 or Blue
 Black Not or Brown

USE PIGGY BACK CONNECTORS

CABLES FOR RB PUMP or Air Break Tank
 To Be Found Inside Lower Front Panel on Right Hand Side at Front



CLASSIC 24 - H7 DISHWASHER ISSUE 2 FROM Serial ???-241 to ???-328

2

September 2003 WO

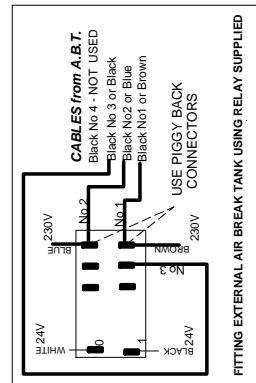
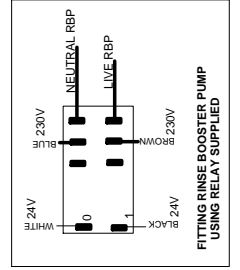
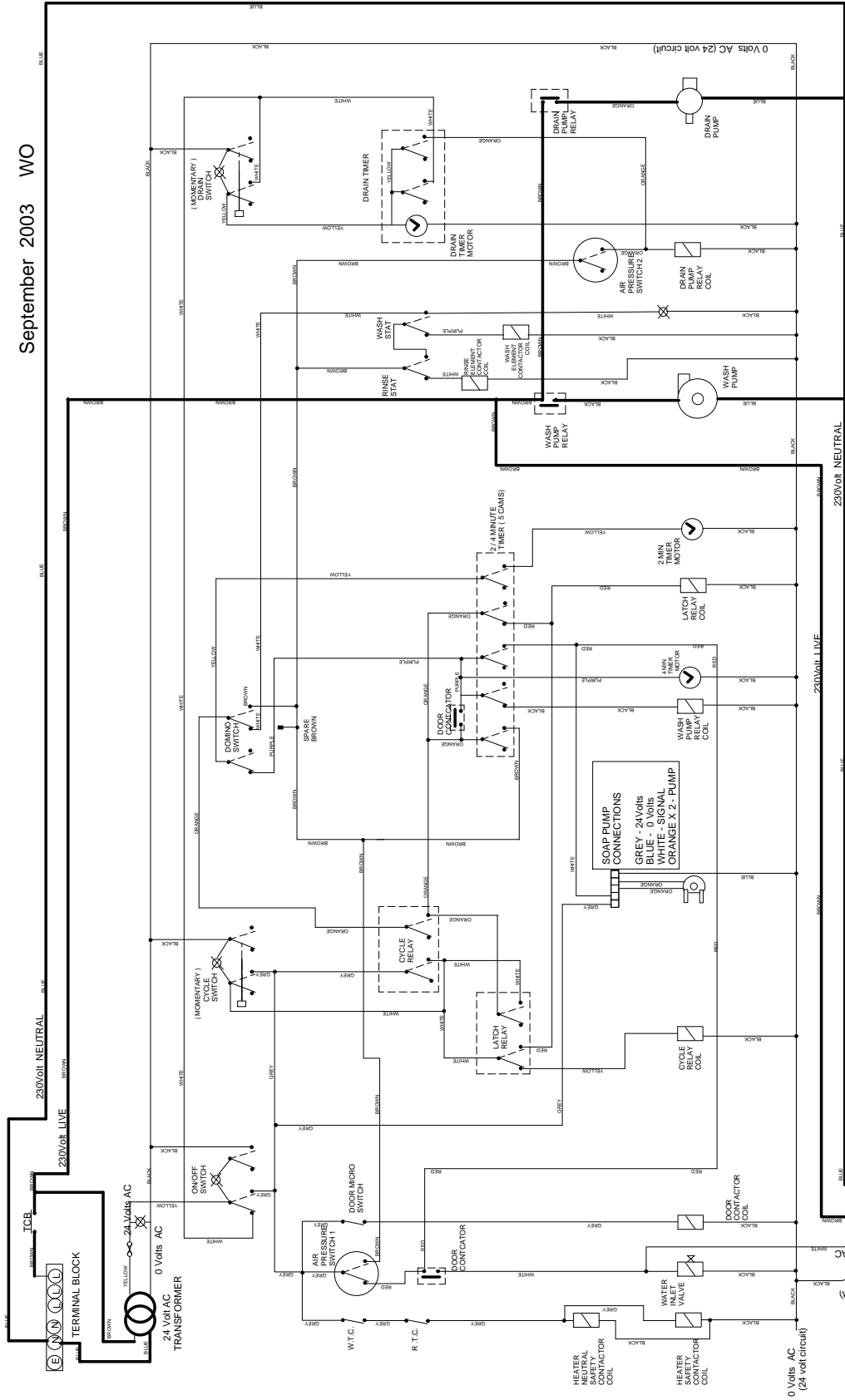

CABLES FOR RE PUMP or Air Break Tank
To Be Found inside Lower Front Panel on right hand Side at Front

CABLES from A.B.T.
Black No 4 - NOT USED
Black No 3 or Black
Black No 2 or Blue
Black No 1 or Brown

USE PIGGY BACK CONNECTORS

Part No :CONT/ 51 24 VOLT RELAY

CLASSIC H750 24V COMPONENT WIRING

ISSUE 2 FROM Serial No ????-241 To ??? -328



2

FRONT OF MACHINE

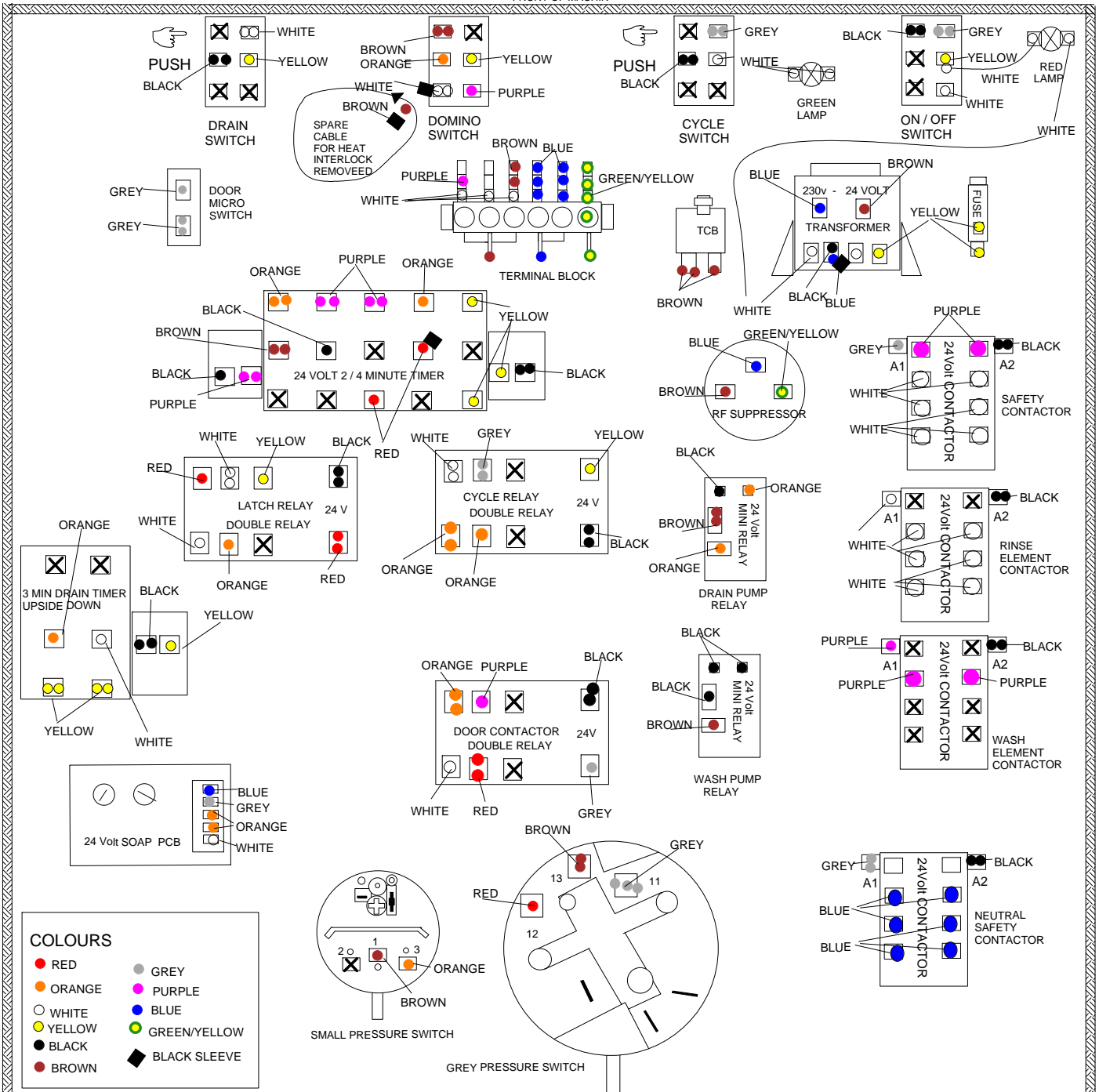

COLOURS

● RED	● GREY
● ORANGE	● PURPLE
○ WHITE	● BLUE
● YELLOW	● GREEN/YELLOW
● BLACK	◆ BLACK SLEEVE
● BROWN	

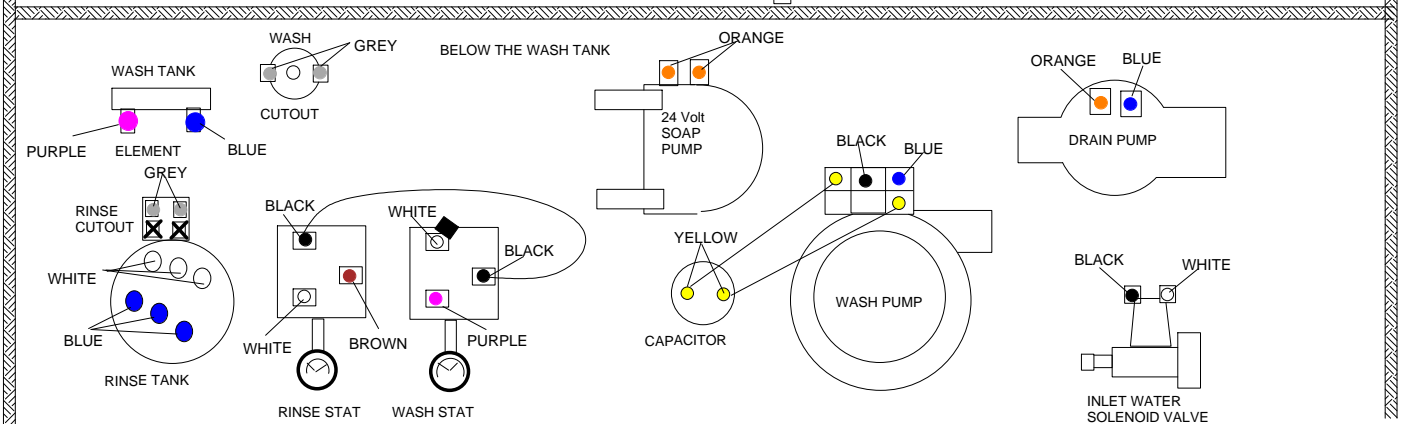

CLASSIC H750 AB 24V COMPONENT WIRING ISSUE 1 FROM Serial ???-216 to ???-241

1

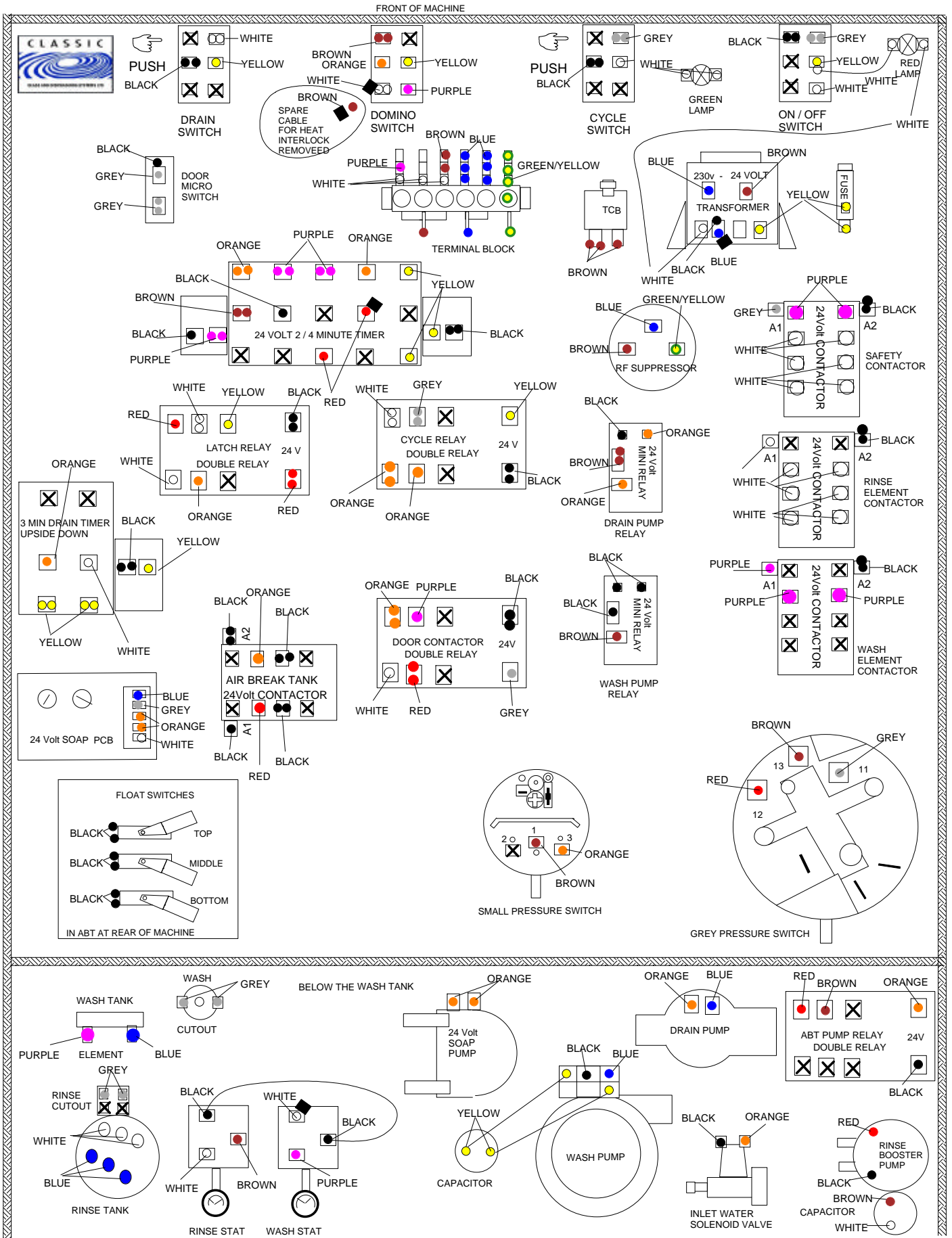

CLASSIC 24 - H7 AIR BREAK TANK DISHWASHER FROM Serial No ???-214 TO ???-241



September 2003 WO

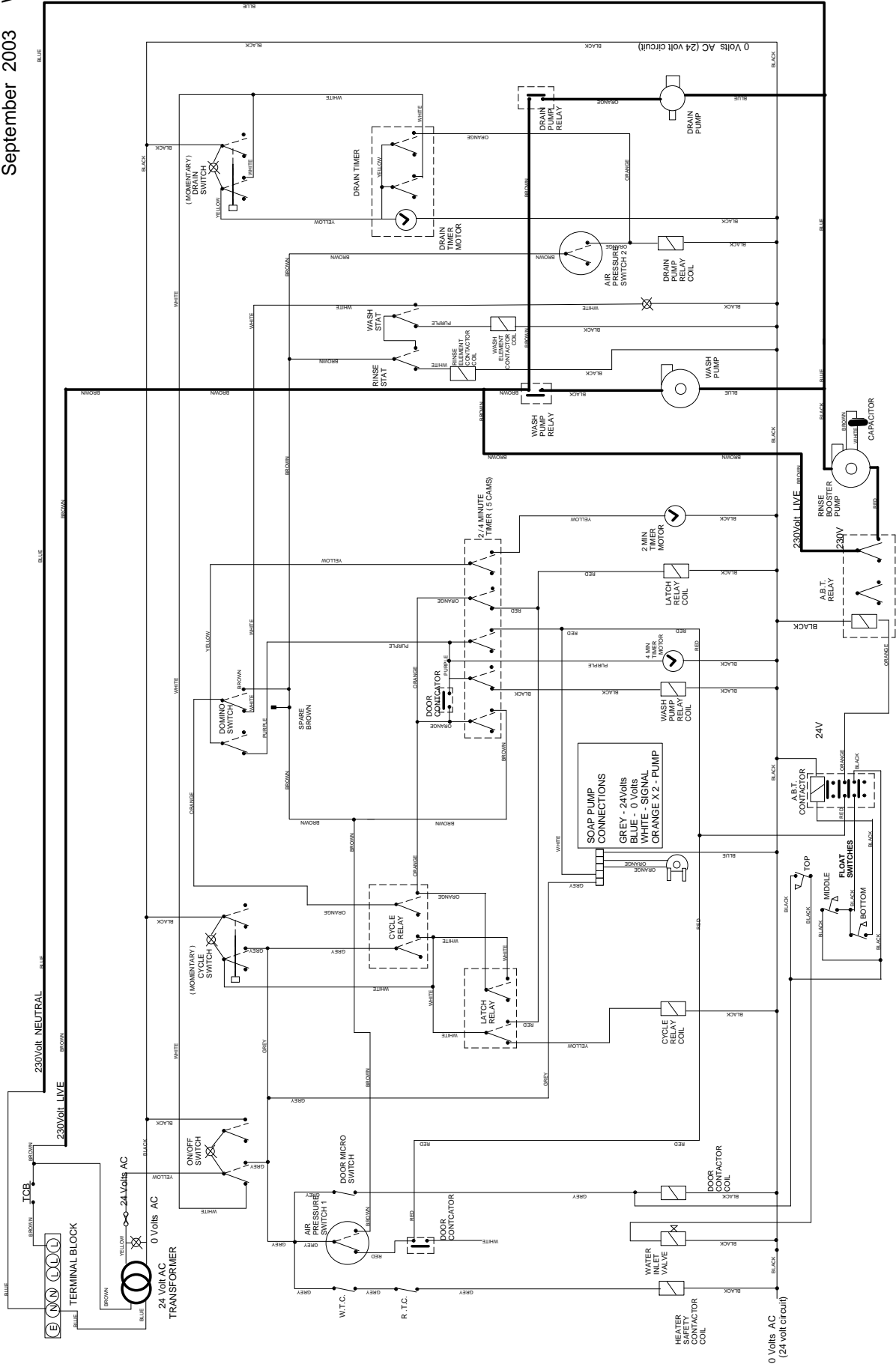

1



CLASSIC 24 - H7 AIR BREAK TANK DISHWASHER ISSUE 2 FROM Serial ???-241 to ???-328

September 2003 WO

2

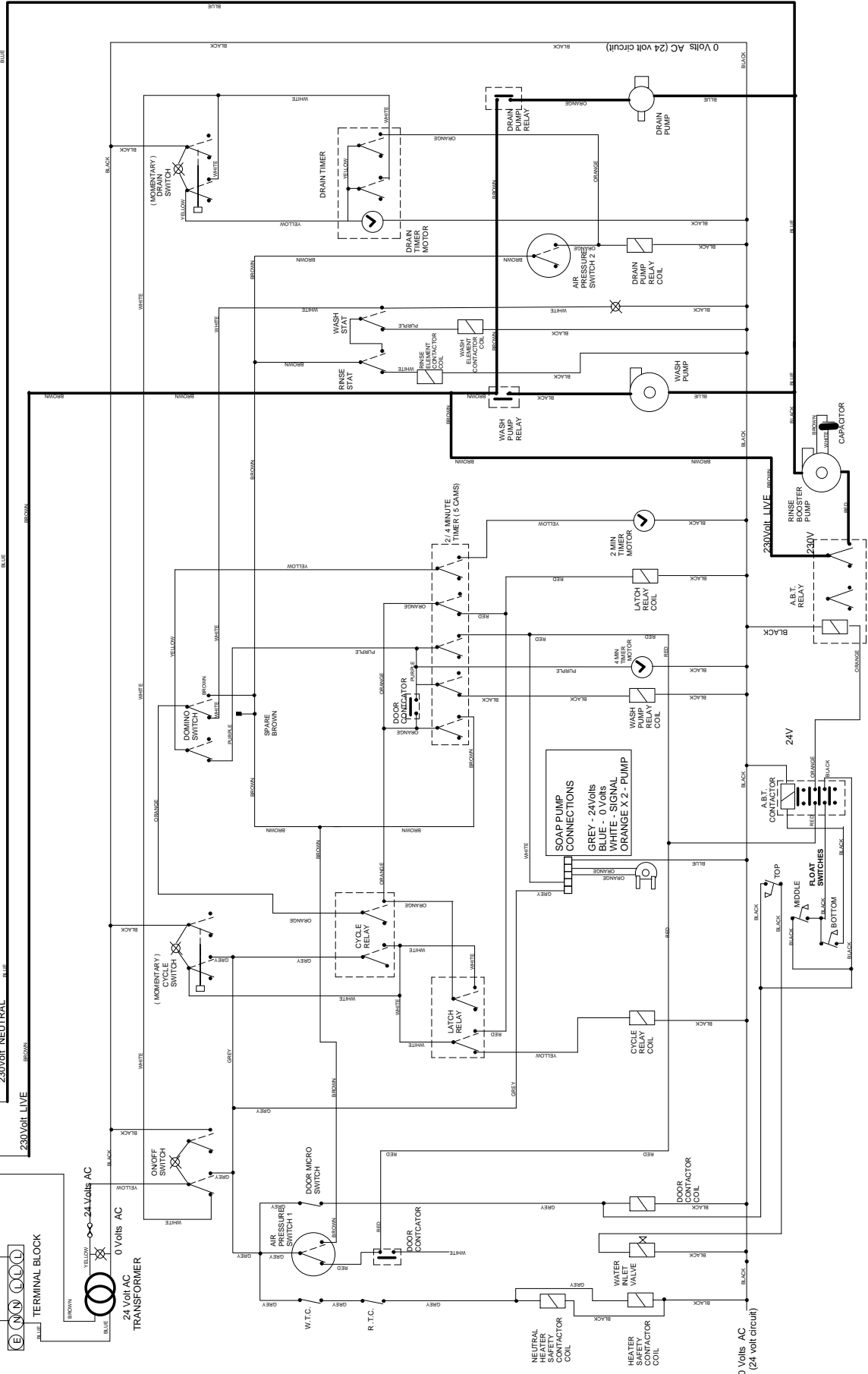

CLASSIC H7 AB 24V COMPONENT WIRING ISSUE 2 FROM Serial ???-241 to ???- 328



2

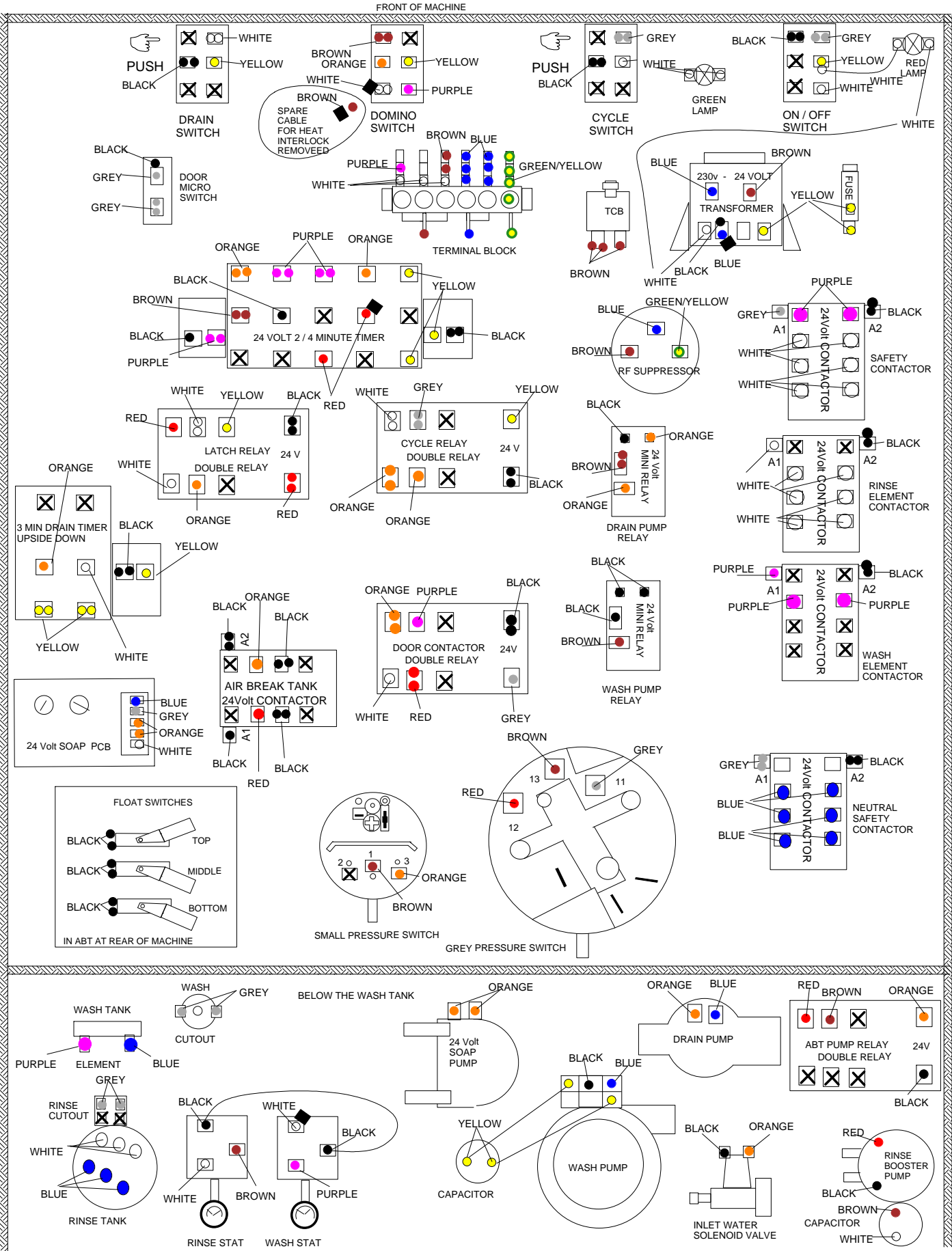

CLASSIC 24 RANGES OF GLASS & DISHWASHERS

REMOVING HEAT INTERLOCK – E1 E2 E3 H5 if necessary?

IDENTIFY

On the 'CYCLE RELAY' (inner relay of two) there is a WHITE cable with a 'Black' terminal sleeve, and floating BROWN cable with a Black sleeve

Change the cables over so the BROWN cable is on the Relay and the white cable floating.

Put the clear rubber cover from the BROWN over the end of the WHITE cable for safety.

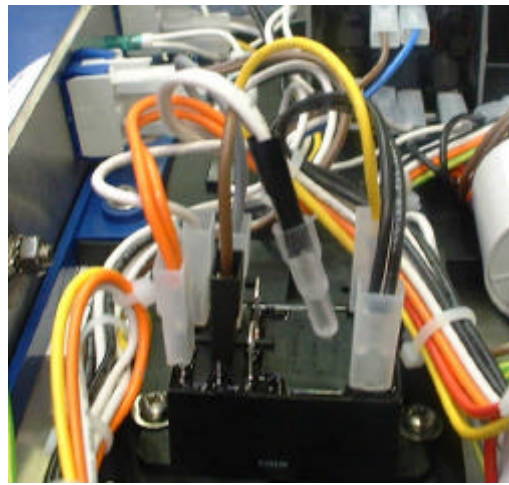

H7 ONLY

IDENTIFY 2 / 4 minute Switch ,

WHITE cable with Black terminal sleeve on the bottom connection (A)

BROWN cable with Black terminal sleeve hanging loose (B)

Change over the BROWN cable for the WHITE cable

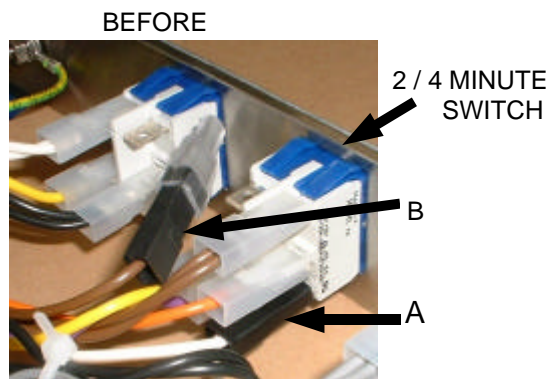

INTERLOCK ON

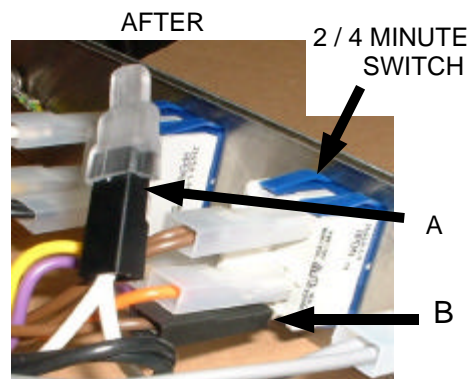

INTERLOCK OFF

CLASSIC 24 RANGES OF GLASS & DISHWASHERS

_____ The next 2 pages are for training and identifying the interlock circuit.

Drawing 1 Select Position

Where you select a cycle by pressing the cycle switch.
The switch will illuminate but will not start until the machine is up to temperature
EXCEPT H750 with '4 MIN' selected
All machines with Heat interlock removed.

Drawing 2 Start Position

The machine is up to temperature and the cycle will start (Orange cable to timer)
We have detailed the '2/4 MIN' switch, which indicates either a signal from the thermostats (White Cable) or constant power (Brown Cable)

Drawing 3 Changeover Position

When the machine starts to rinse a signal from the timer (RED Cable) changes the circuit so that when the cycle is completed the machine will stop and you have to select a cycle again to start the machine

Next Page Fault Finding – Help on possible faults, which may occur

INTERLOCK CIRCUITS FOR E1 E2 E3 H5 H7

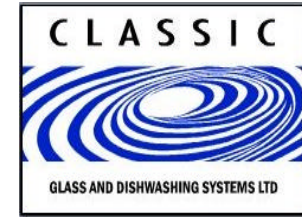

1 → 2 → 3

SELECT POSITION

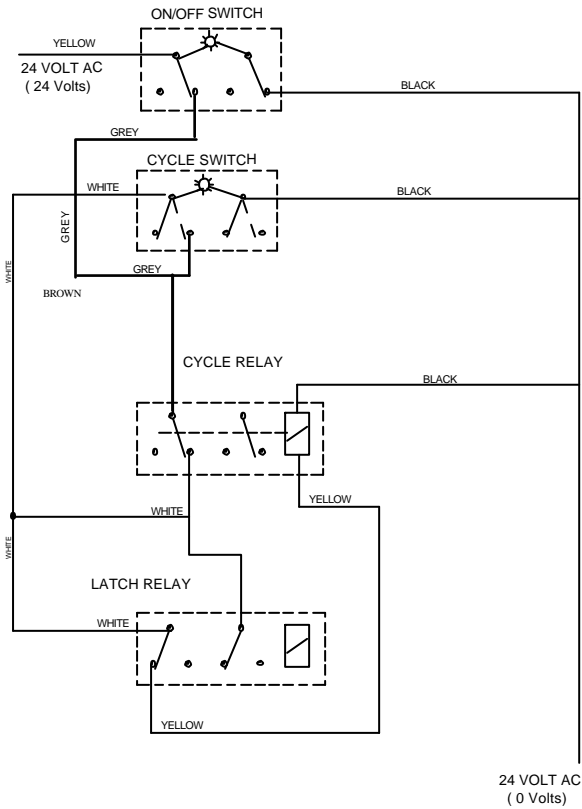

START POSITION

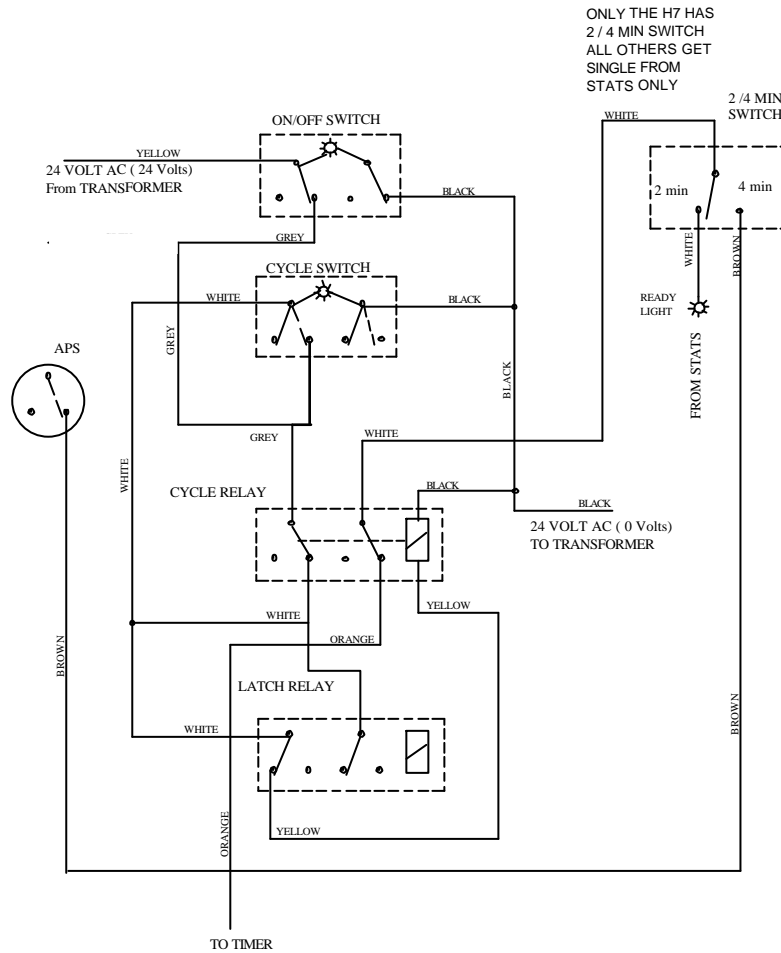

CHANGEOVER POSITION

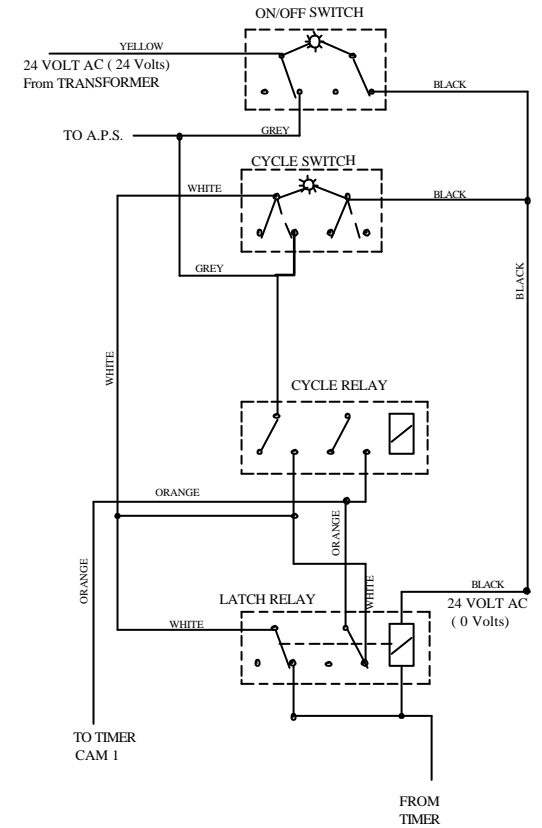

<u>SYMPTOMS</u>	<u>FAULT</u>
<u>POWER AND SERVICES</u>	
Red Light next to On/Off Switch Not on	A: Not switched on at Wall
Red Light next to On/Off Switch Not on	B: Fuse Open Circuit in Plug or Fuse Box
Red Light next to On/Off Switch Not on	C: Fuse (1.6 amp)/Open Circuit in Machine
Will not stop Filling (ECO3 H750) - DURING INSTALATION	Waste hose Below water level
<u>FILLING</u>	
Will Not Fill with water	Faulty On/Off Switch
Will Not Fill with Water	Faulty Pressure Switch
Will Not Fill with Water	Faulty Water Inlet Solenoid Valve
Will Not Fill With water	Water turned off at Mains or Tap or Water Softener
Will not stop filling - all models	Air Trap- Leaking Air or Broken or twisted or Blocked
Will not stop filling - all models	Air Trap to pressure Switch - Off or Leaking Air
Will not stop filling - all models	Pressure Switch Faulty
Will not stop filling - all models	Inlet Solenoid Valve Faulty
Will not Stop Filling (ECO1 ECO2 H500 H800)	Drain Plug Not in Drain Hole
<u>HEATING</u>	
Will not Stop Heating Rinse Tank (after resetting thermal trip) Thermostat will not switch off	Thermostat Faulty
Will not Stop Heating Rinse Tank (after resetting thermal trip) Thermostat WILL switch off	Rinse Contactor Close Circuit
Will not Stop Heating Wash Tank (after resetting thermal trip) Thermostat will not switch off	Thermostat Faulty
Will not Stop Heating Wash Tank (after resetting thermal trip) Thermostat WILL switch off	Wash Contactor Close Circuit
Heating - NO Water in Wash Tank (after resetting Wash Tank Thermal Trip)	Air pressure Switch Faulty
Not Heating Either Tank (full of water and not still filling)	Rinse Thermal Cut-out Tripped Out(resetable)
Not Heating Either Tank (full of water and not still filling)	Burnt of Cable
Not Heating Either Tank (full of water and not still filling)	Element Open Circuit
Not Heating Rinse Tank (full of water and not still filling)	Rinse Contactor Open Circuit
Not Heating Wash Tank (full of water and not still filling)	Wash Contactor Open Circuit
Not Heating Wash Tank (full of water and not still filling)	Wash Thermal Cut-out Tripped out (resetable)
Not Heating Wash Tank (full of water and not still filling)	Burnt Cable
Not Heating Wash Tank (full of water and not still filling)	Element Open Circuit
<u>WASHING</u>	
Restarts the cycle Ready light goes out during in Rinse but comes back on during Wash	Latch Relay – Orange to White Closed Circuit
Restarts the cycle without pressing the cycle switch(if ready light is on) or (Interlock is removed)	Latch Relay – coil Open Circuit
Restarts the cycle without pressing the cycle switch(if ready light is on) or (Interlock is removed)	Cycle Switch – Grey to White Closed Circuit
Wash as normal -Completes cycle but will not rinse	Door Relay – Red to White Closed Circuit
Washes 2 cycles then starts to Fill/Rinse (H750 or ECO3 ONLY) may refill or fill & Syphon water	Waste Hose - too low or no air break or push down in stand pipe
Washes as Normal BUT Cycle light goes out during rinse	Latch Relay - Orange to White Open Circuit
Washes as normal BUT Cycle Light will not stay no during wash BUT will during in Rinse	Cycle Relay – Grey to white Open Circuit
Washes as Normal BUT Drain Pump will not run during in Rinse	Door Relay – Red to White Open Circuit
Washes as normal on first cycle then washes second cycle NO light in cycle switch but comes on during rinse	Cycle Relay – Orange to White Closed Circuit
Will Not Start but Ready Light on & Cycle Light On	Cycle Relay – Orange to White Open Circuit
Will Not Start Cycle BUT Cycle Light on when cycle is requested- light stays on	Door Relay – Orange to purple Open Circuit
Will Not Start Cycle BUT Cycle Light on when pressed – goes out when released	Cycle Relay - coil Open Circuit
Will Not Start Cycle BUT Cycle Light on when pressed – goes out when released	Latch Relay – Yellow to White Open Circuit
<u>WASH PUMP</u>	
WASH PUMP will NOT stop running	Wash pump Contactor Closed Circuit
Cycle Starts But Wash PUMP Will NOT run	Wash Pump Relay Open Circuit
Cycle Starts But Wash PUMP Will NOT run	Wash Pump or Capacitor Faulty
<u>DRAIN PUMP</u>	
Drain PUMP will NOT Stop running	Drain Pump Contactor Closed Circuit
Drain Pump Will Not Run	Blocked
Washes as Normal BUT Drain Pump will not run during in Rinse	Door Relay – Red to White Open Circuit



WO 47/2003

24VOLT CONTROL SYSTEM
FROM JULY 2003
Serial No ?????- 328

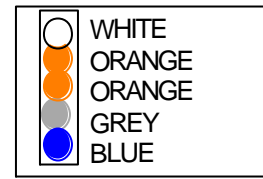

SOAP PCB (CLM211)

H7 DISHWASHER

AIR PRESSURE SWITCH
APS 1 - GREY (7.12.9/E)

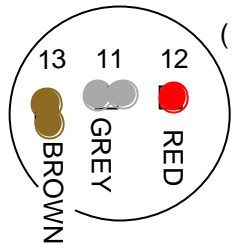

AIR PRESSURE SWITCH
APS2 - SMALL (7.12.9)

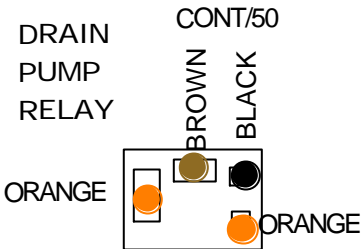
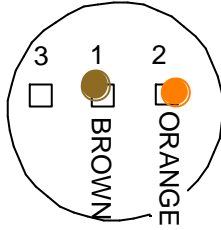

SAFETY CONTACTOR (CONT/51)

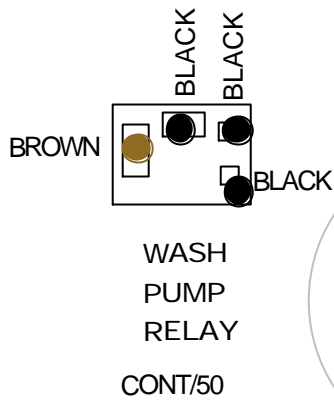
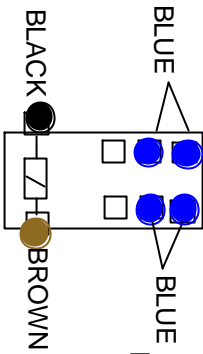

WASH PUMP RELAY
CONT/50

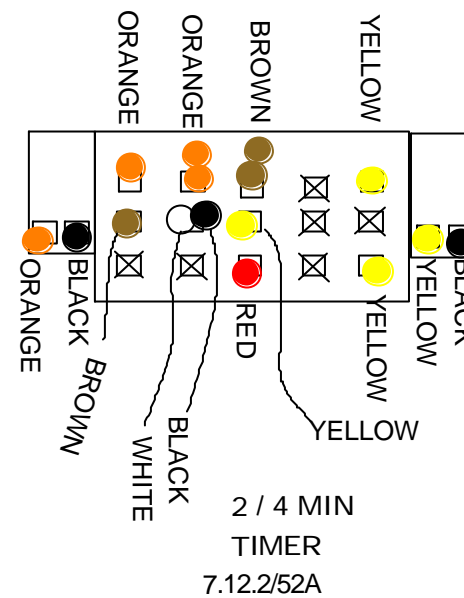
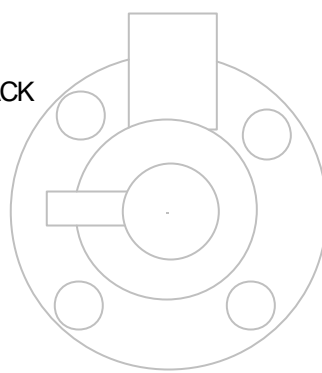

2 / 4 MIN
TIMER
7.12.2/52A

DRAIN
TIMER
7.12.2/55

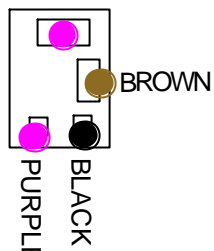
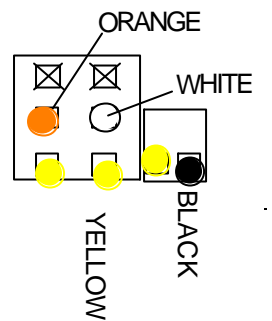

WASH CONTACTOR (CONT/50)

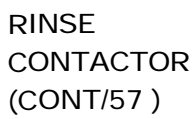

RINSE CONTACTOR (CONT/57)

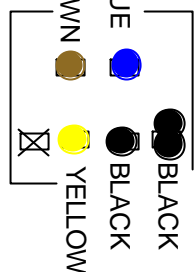
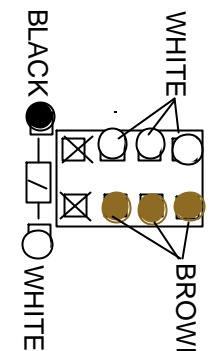

TRANSFORMER
TR-10

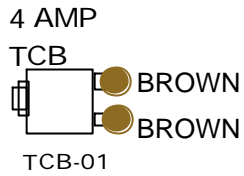

4 AMP
TCB
TCB-01

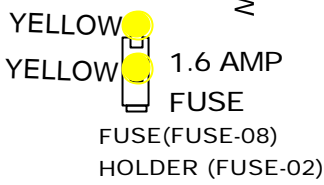

1.6 AMP
FUSE
FUSE(FUSE-08)
HOLDER (FUSE-02)

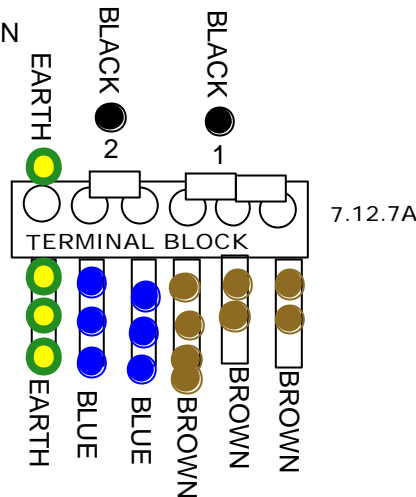

7.12.7A

CYCLE CONTACTOR
CONT/54

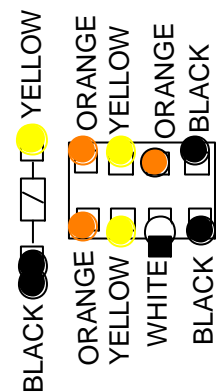

DOOR SWITCH
7.14.10/1

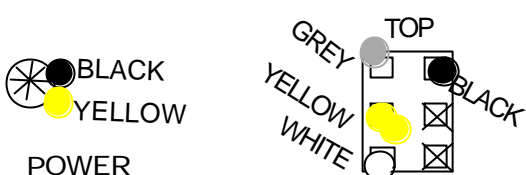

POWER ON
LIGHT
7.12.6/6

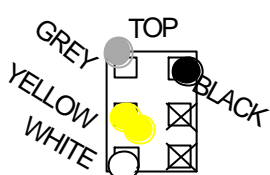

ON/OFF
SWITCH
7.12.4/50

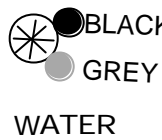

WATER
HOT
LIGHT
7.12.6/7

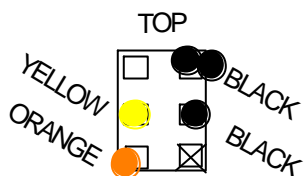

CYCLE
SWITCH
7.12.4/51

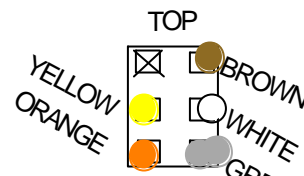

2 / 4 MIN
SWITCH
7.12.4/52

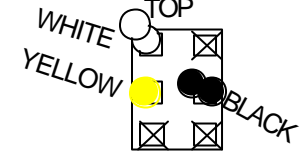

DRAIN
SWITCH
7.12.4/51

FRONT OF MACHINE

ITEMS BELOW THE WASH TANK

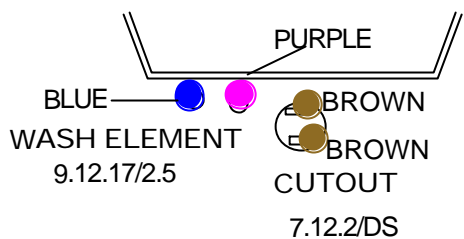

WASH ELEMENT
CUTOUT
9.12.17/2.5
7.12.4/D

CUTOUT
7.12.2/DS

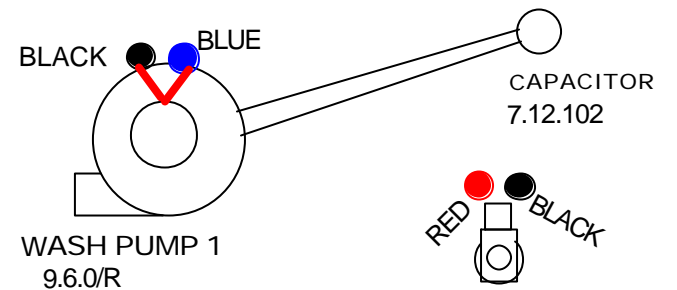

WASH PUMP 1
9.6.0/R

CAPACITOR
7.12.102

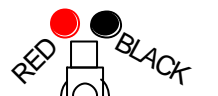

INLET
WATER
SOLENOID
VALVE
7.12.12/51

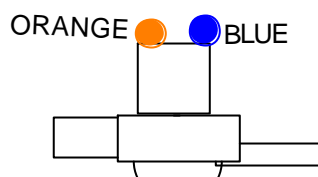

DRAIN PUMP
DP2

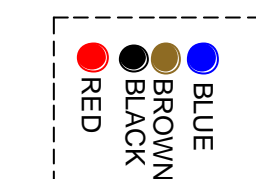

SPARE CABLES
FOR CONTACTOR
TO FIT RBP or ABT

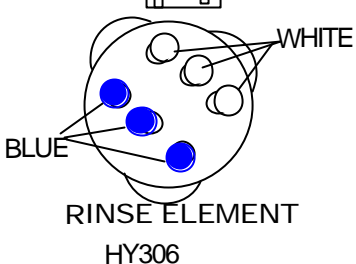

RINSE ELEMENT
HY306

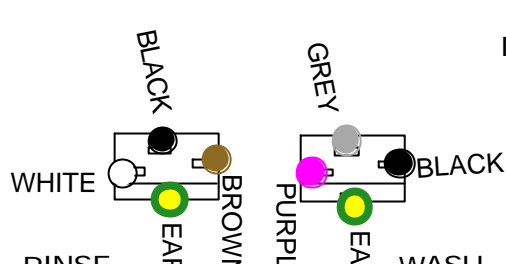

RINSE
STAT
7.12.1/2

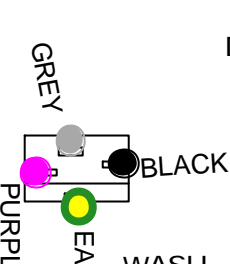

WASH
STAT
7.12.1/2

H7 DISHWASHER

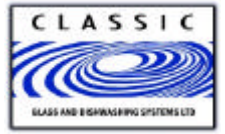

WO 4/7/2003

24Volt CONTROL SYSTEM
FROM DEC 2003
Serial No ?????- 349

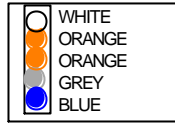

SOAP PCB (CLM211)

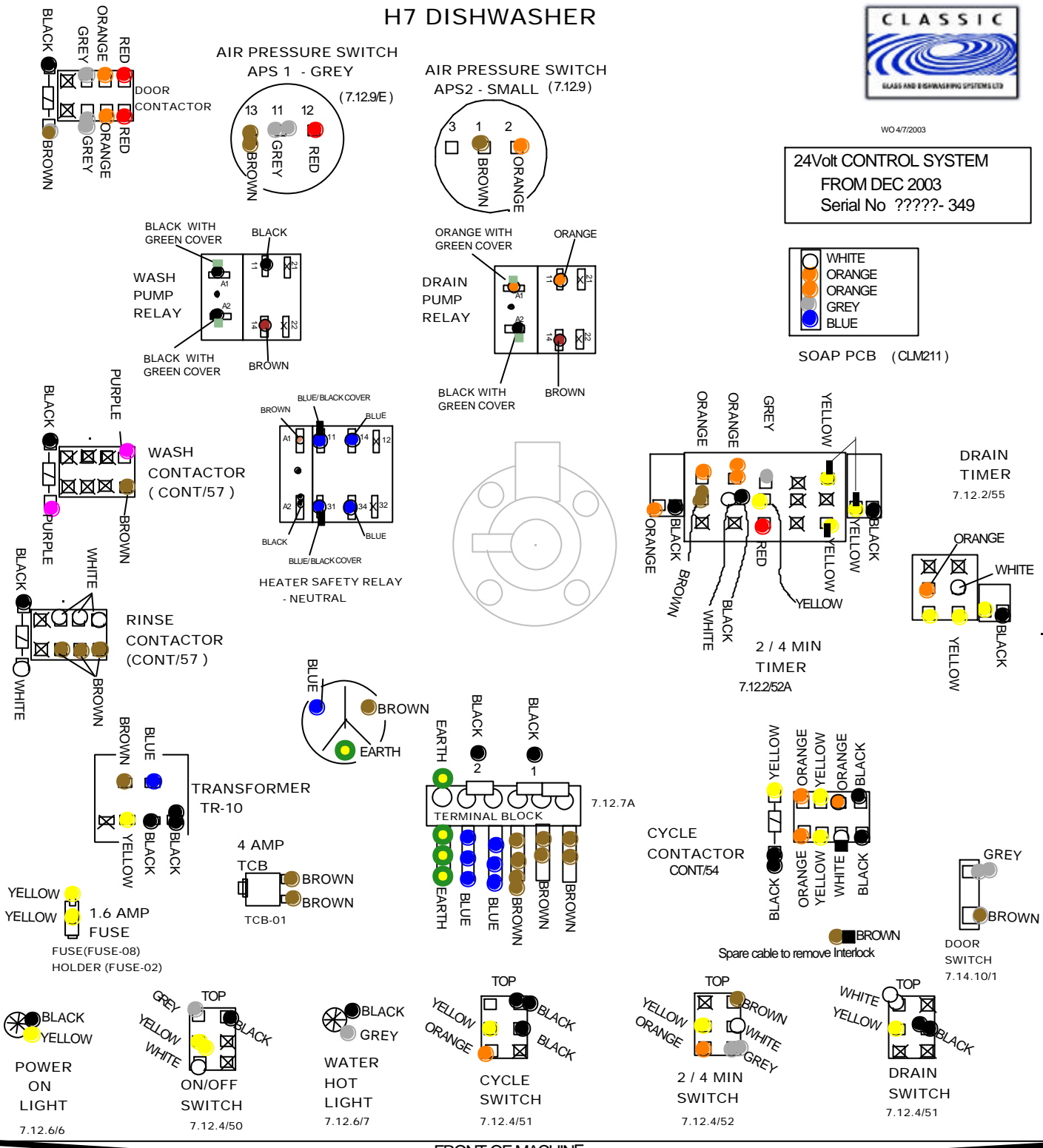

FRONT OF MACHINE

ITEMS BELOW THE WASH TANK

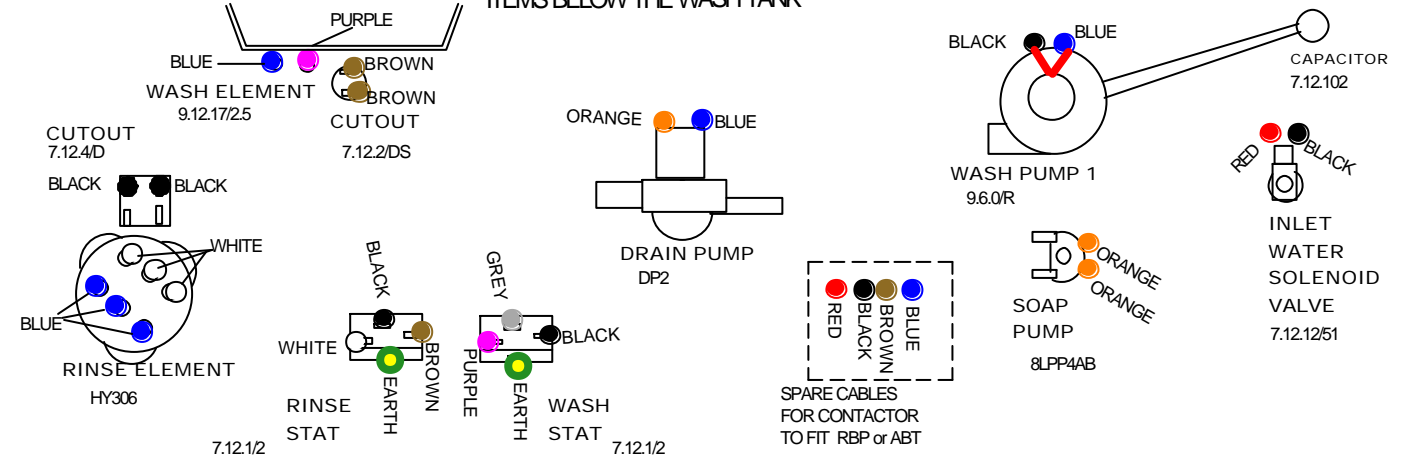

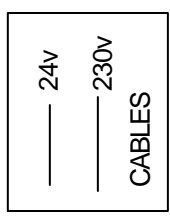
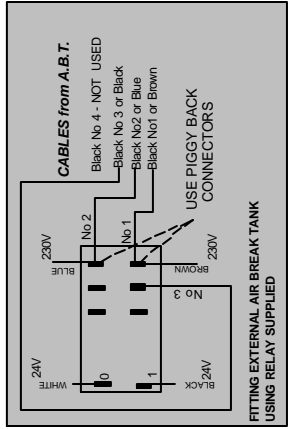
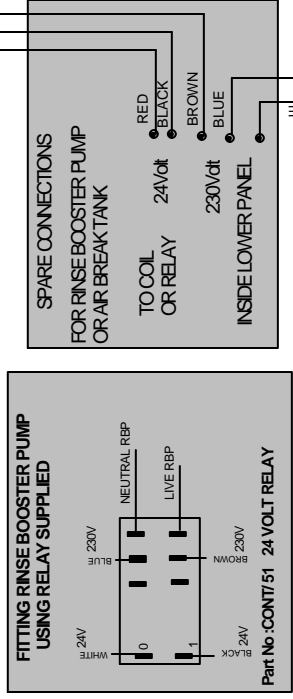
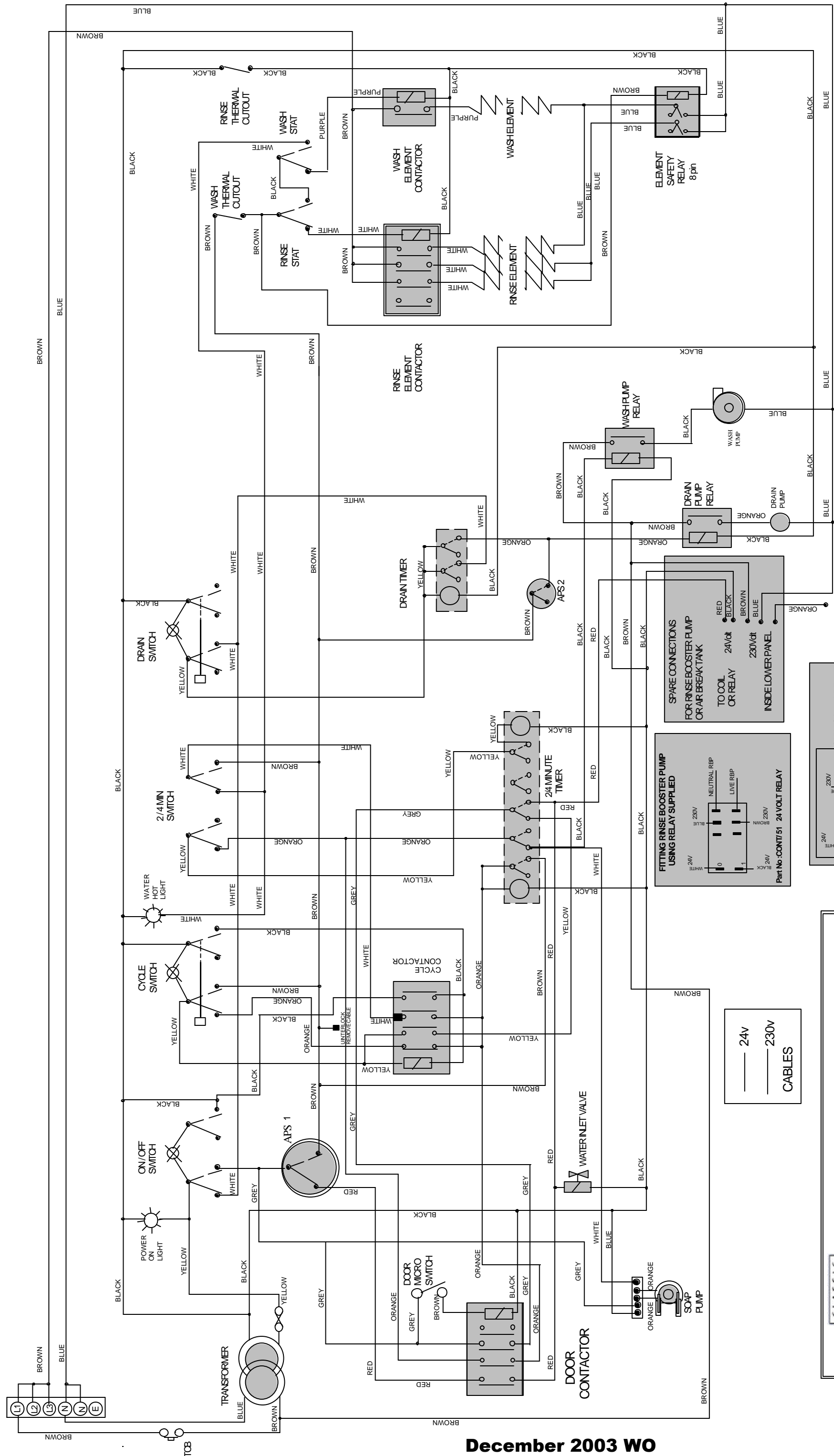

CLASSIC H7 DISHWASHER
24Volt CONTROL SYSTEM

4/7/2003

REVISION H
LM-H7-24

Drawing TNL
CLASSIC
DAVID INTERNATIONAL LTD.

H7 DISHWASHER



WO 4/7/2003

24Volt CONTROL SYSTEM
FROM January 2004
Serial No ?????- 402

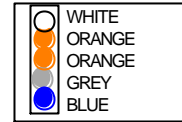

SOAP PCB (CLM211)

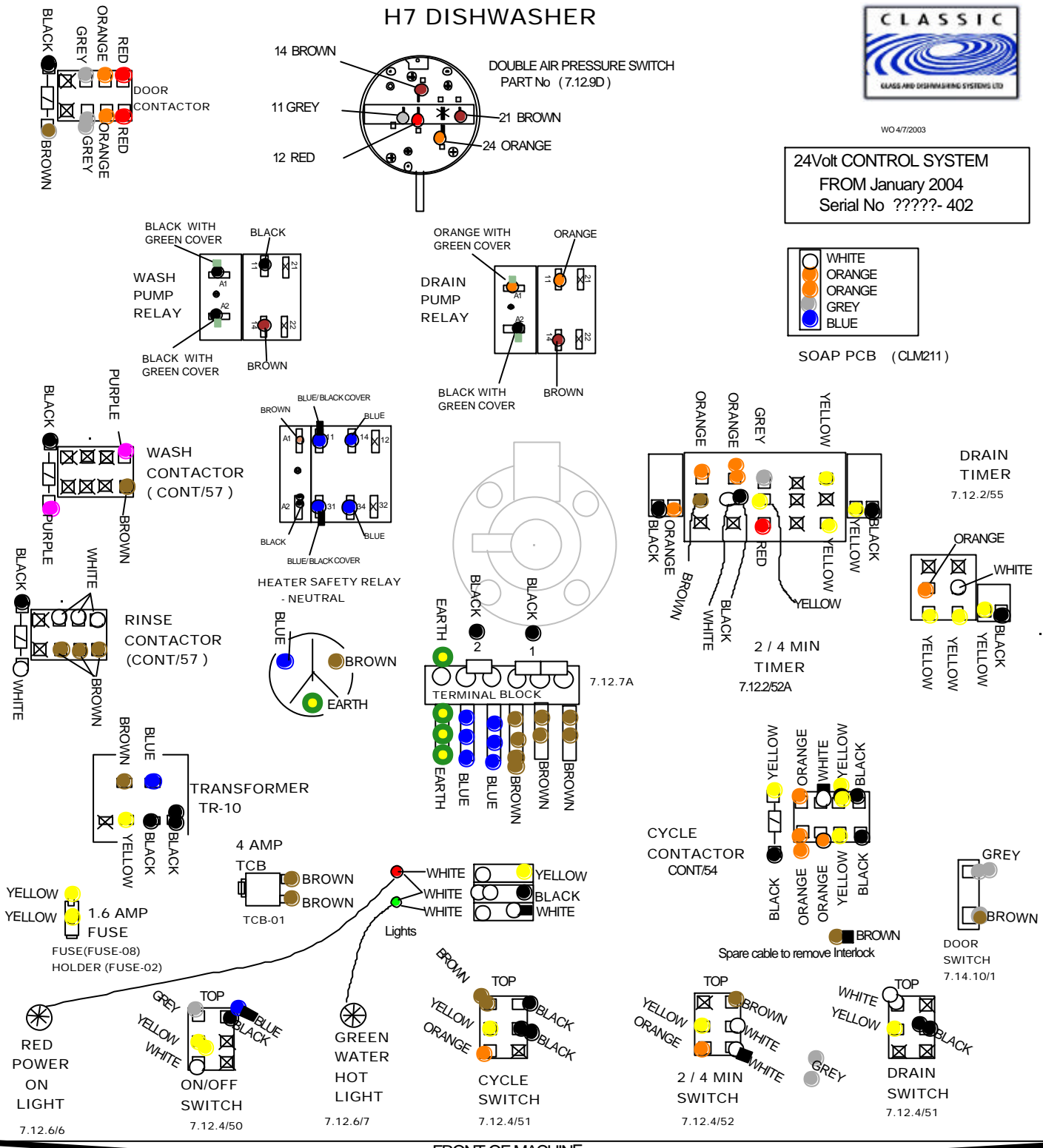

ITEMS BELOW THE WASH TANK

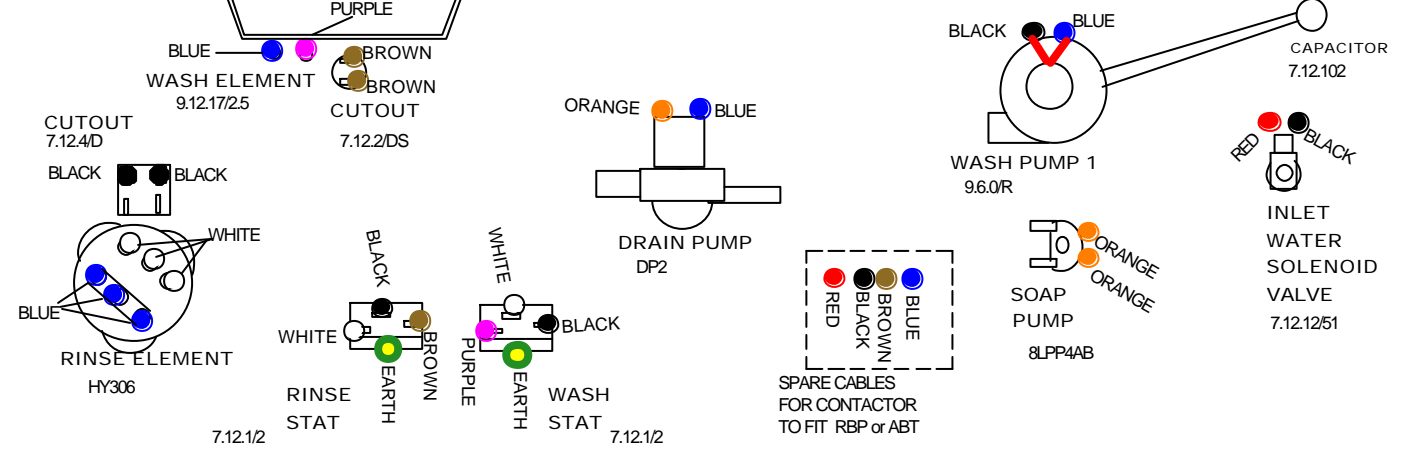

H7 ABT DISHWASHER



WO 12/1/2004

24Volt CONTROL SYSTEM
FROM January 2004
Serial No ?????- 402

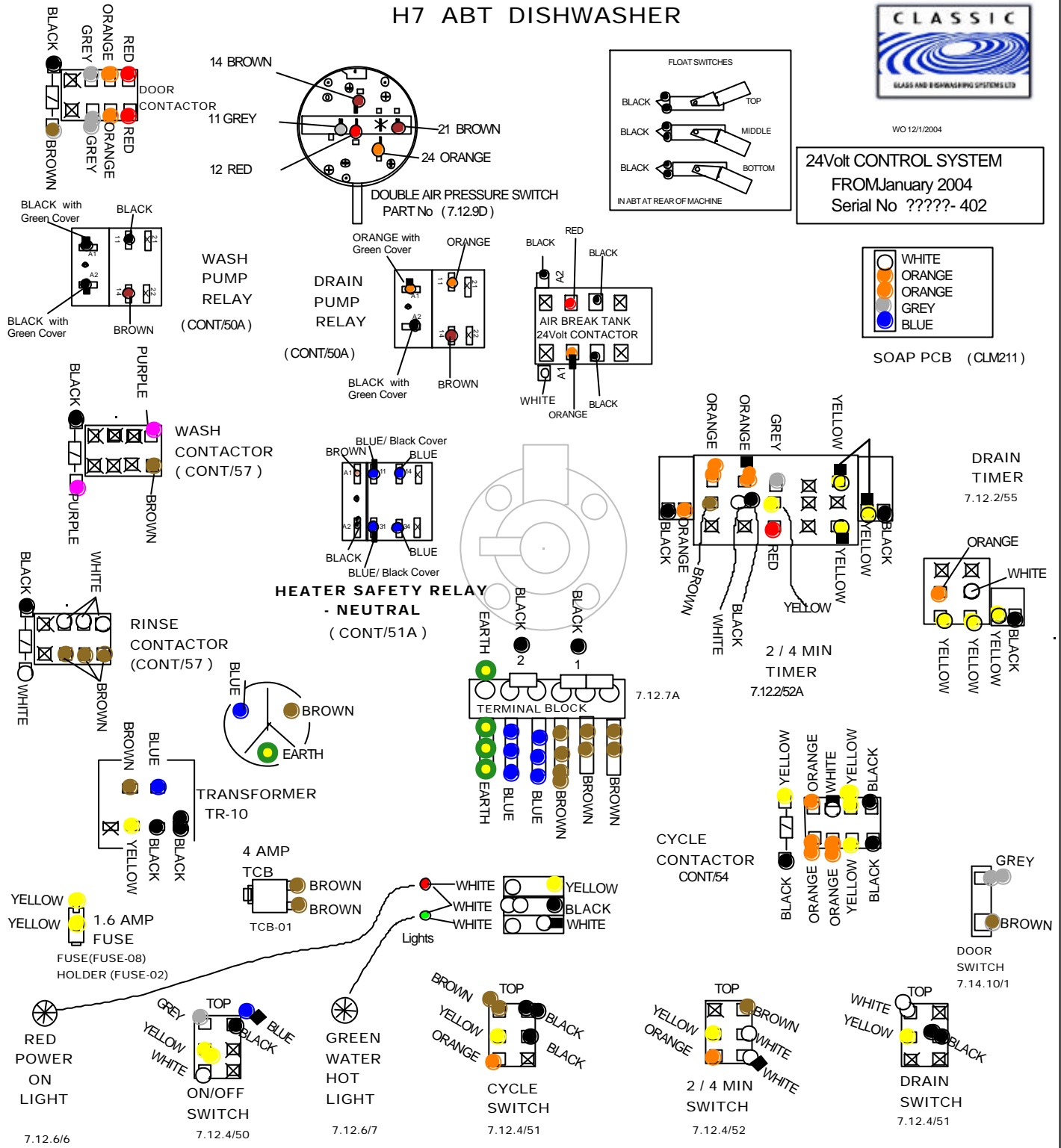

FRONT OF MACHINE

ITEMS BELOW THE WASH TANK

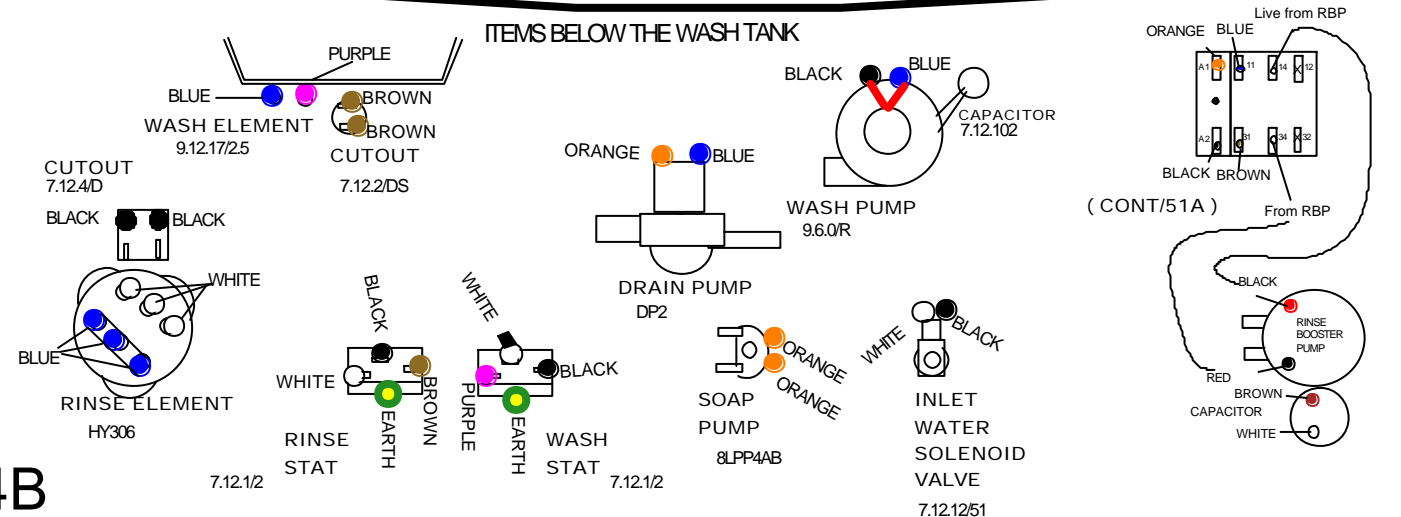

CLASSIC GLASS & DISHWASHING SYSTEMS LTD

FITTING NEW RINSE BOOSTER PUMP TO CLASSIC 24 MACHINES 24volt control

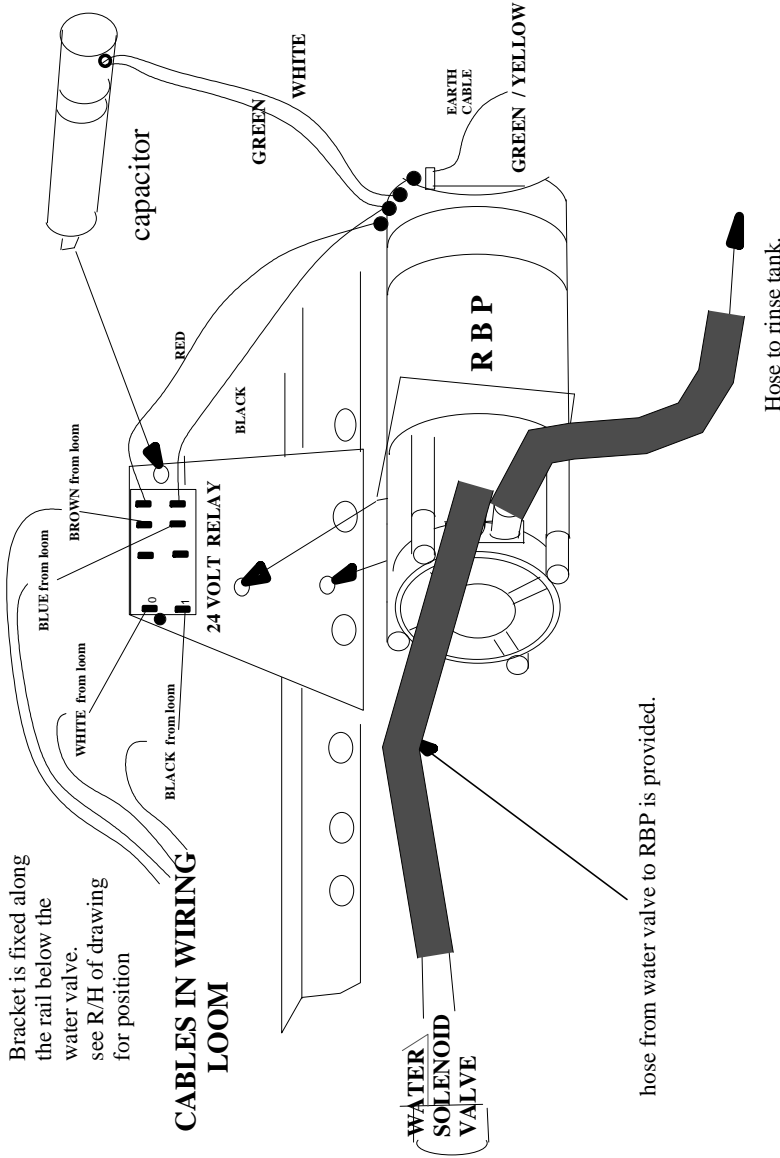

THIS PUMP MUST BE CONNECTED TO EARTH

- RBP5A24**
- PART NUMBER
This kit contains
RBP5 RINSE BOOSTER PUMP
7.6.6/30 BRACKET
10 mm NUT & BOLT x 4
WASHER & STAR WASHERS
CONT/51 24 VOLT 8 PIN RELAY
7.8.20 HOSE
7.4.12/1 HOSE CLIP X 2

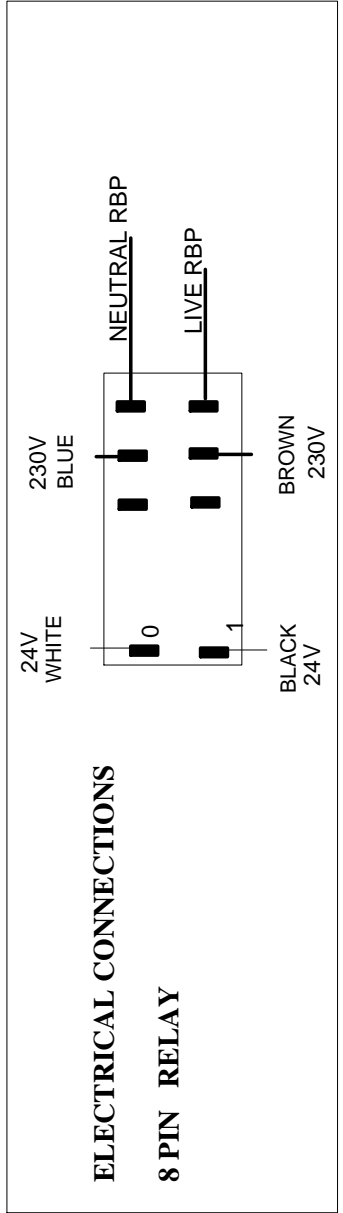

HOLE FIXINGS

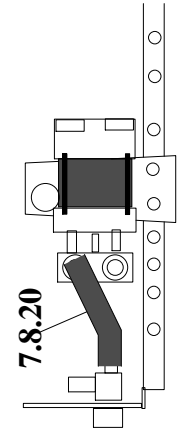

The RBP5 kit of parts are bolted to the bracket when it is despatched, you only have to fit the assembly to the machine connect up the hoses and electrical connections.



PCB SOAP PUMP ADJUSTMENT

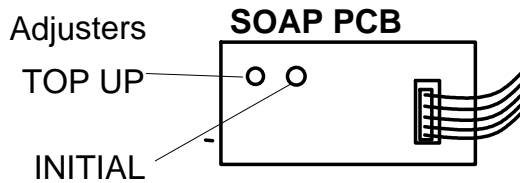

When the machine is switched on the soap pump will operate on the initial setting. Each wash cycle the pump operate a 'TOP UP' dose.

If the machine is turned off for any reason, when it is switched back on it will give an INITIAL dose

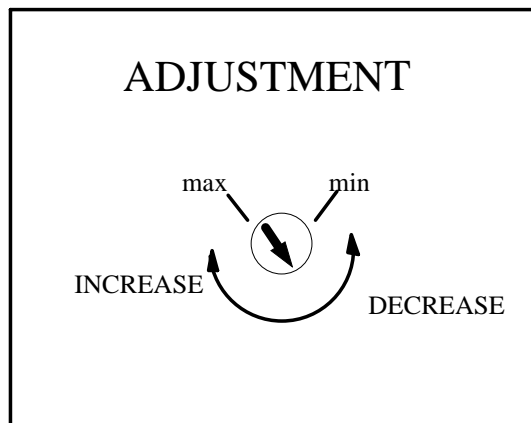

SOAP PUMP RUNNING TIMES - FOR CLASSIC SOAP

INITIAL DOSE

Model	HARD WATER		SOFT WATER	
	GLASSWASH	DISHWASH	GLASSWASH	DISHWASH
H500		50sec		40sec
ECO3	2min 35sec		2min 15sec	
H750	2min 35sec	1min 45sec	2min 15sec	1min 25sec

TOP UP DOSE

Model	HARD WATER		SOFT WATER	
	GLASSWASH	DISHWASH	GLASSWASH	DISHWASH
H500		10sec		8sec
ECO3	13sec		11sec	
H750	13sec	10sec	11sec	8sec

HYDRO H7 H750 & H750 NL

DOWN RATING 6Kw RINSE ELEMENT TO 3 Kw

To Der-rate suitable for
15 amp supply

(Gives 3kw Rinse Element)

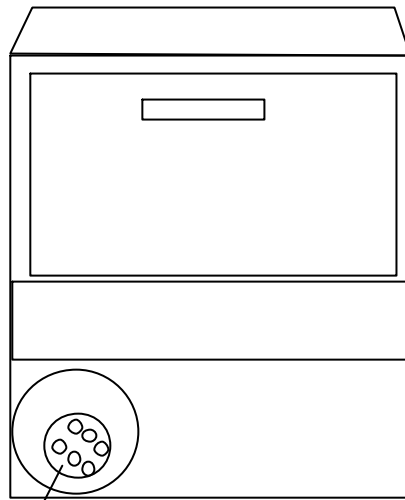

Parts supplied

- 1 x 2.5MM Cable with ring tags
- 1 Brass Link

